



Grayhill, Inc.

## 62S11-N4-060SH

Numéro d'article:

62S11-N4-060SH

Fabricant / marque:

Grayhill, Inc.

Description du produit

ROTARY ENCODER OPTICAL 32PPR

Feuilles de données:

 62S11-N4-060SH.pdf

Statut RoHS

 Sans plomb / Conforme RoHS

Etat du stock

2262 pcs stock

Bateau de

Hong Kong

Manière d'expédition

DHL/Fedex/TNT/UPS/EMS

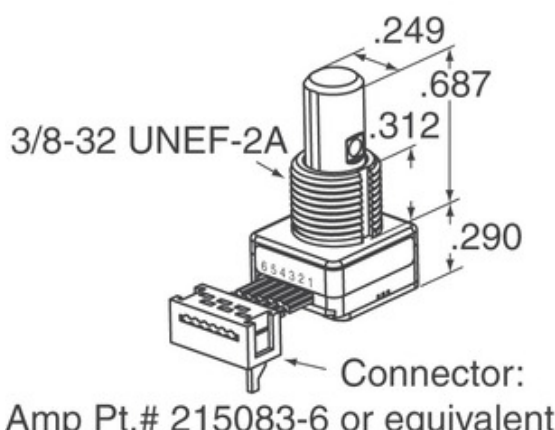

L'image peut être une représentation. Voir les spécifications pour les détails du produit.

[DEMANDE DE DEVIS](#)







### Spécifications de 62S11-N4-060SH

NUMÉRO D'ARTICLE	62S11-N4-060SH
FABRICANT	Grayhill, Inc.
LA DESCRIPTION	ROTARY ENCODER OPTICAL 32PPR
ÉTAT SANS PLOMB / ÉTAT ROHS	Sans plomb / Conforme RoHS
QUANTITÉ DISPONIBLE	2262 pcs
FICHE TECHNIQUE	 62S11-N4-060SH.pdf
TENSION - ALIMENTATION	5V
STYLE DE RACCORDEMENT	Cable Leads
SÉRIES	62S
VIE ROTATIONAL (CYCLES MIN)	1M
IMPULSIONS PAR TOUR	32
LE TYPE DE SORTIE	Quadrature (Incremental)
AUTRES NOMS	62S11N4060SH
ORIENTATION	Vertical
TYPE DE MONTAGE	Panel Mount
NIVEAU DE SENSIBILITÉ À L'HUMIDITÉ (MSL)	1 (Unlimited)
STATUT SANS PLOMB / STATUT ROHS	Lead free / RoHS Compliant
TYPE DE CODEUR	Optical
DETENT	No
COMMUTATEUR INTÉGRÉ	Yes
TYPE D'ACTIONNEUR	1/4" Dia Flatted End

### Tags associés

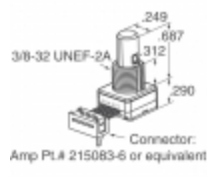
Grayhill, Inc. 62S11-N4-060SH	Distributeur 62S11-N4-060SH	62S11-N4-060SH Fournisseur
Prix 62S11-N4-060SH	62S11-N4-060SH Photos	Image 62S11-N4-060SH
62S11-N4-060SH PDF Fiche technique	62S11-N4-060SH Télécharger la fiche technique	62S11-N4-060SH Fiche technique
Action 62S11-N4-060SH	Acheter 62S11-N4-060SH	Acheter Grayhill, Inc. 62S11-N4-060SH
Grayhill, Inc. 62S11-N4-060SH	Grayhill, Inc. Fournisseur	Distributeur Grayhill, Inc.
Grayhill, Inc. 62S11-N4-060SH	Grayhill Inc. 62S11-N4-060SH	

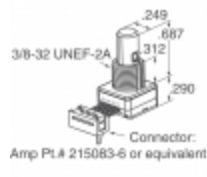
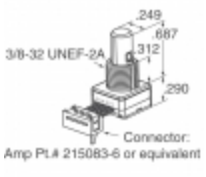
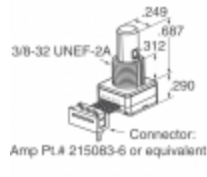
### Produits connexes

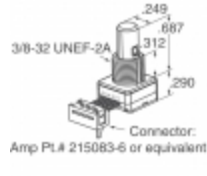
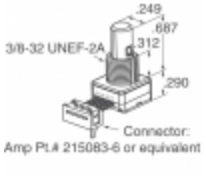
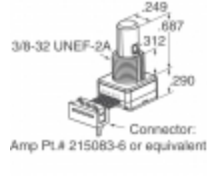
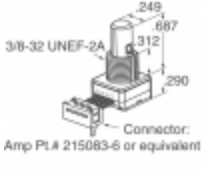
 <p><b>62S11-N4-025C</b> Fabricants: Grayhill, Inc. La description: ROTARY ENCODER OPTICAL 32PPR En stock: 1970 pcs</p> <p><a href="#">RFQ</a></p>	 <p><b>62S11-N5-025CH</b> Fabricants: Grayhill, Inc. La description: ROTARY ENCODER OPTICAL 32PPR En stock: 2083 pcs</p> <p><a href="#">RFQ</a></p>
 <p><b>62S11-N5-040C</b> Fabricants: Grayhill, Inc. La description: ROTARY ENCODER OPTICAL 32PPR En stock: 2106 pcs</p> <p><a href="#">RFQ</a></p>	 <p><b>62S11-N5-025C</b> Fabricants: Grayhill, Inc. La description: ROTARY ENCODER OPTICAL 32PPR En stock: 2408 pcs</p> <p><a href="#">RFQ</a></p>
 <p><b>62S11-N4-P</b> Fabricants: Grayhill, Inc. La description: ROTARY ENCODER OPTICAL 32PPR En stock: 1912 pcs</p> <p><a href="#">RFQ</a></p>	 <p><b>62S11-N4-120S</b> Fabricants: Grayhill, Inc. La description: ROTARY ENCODER OPTICAL 32PPR En stock: 2038 pcs</p> <p><a href="#">RFQ</a></p>
 <p><b>62S11-N4-PH</b> Fabricants: Grayhill, Inc. La description: ROTARY ENCODER OPTICAL 32PPR En stock: 1970 pcs</p> <p><a href="#">RFQ</a></p>	 <p><b>62S11-N4-020C</b> Fabricants: Grayhill, Inc. La description: ROTARY ENCODER OPTICAL 32PPR En stock: 2083 pcs</p> <p><a href="#">RFQ</a></p>
 <p><b>62S11-N4-025CH</b> Fabricants: Grayhill, Inc. La description: ROTARY ENCODER OPTICAL 32PPR En stock: 1946 pcs</p> <p><a href="#">RFQ</a></p>	 <p><b>62S11-N2-PH</b> Fabricants: Grayhill, Inc. La description: ROTARY ENCODER OPTICAL 32PPR En stock: 1760 pcs</p> <p><a href="#">RFQ</a></p>
 <p><b>62S11-N3-PH</b> Fabricants: Grayhill, Inc. La description: ROTARY ENCODER OPTICAL 32PPR En stock: 1856 pcs</p> <p><a href="#">RFQ</a></p>	 <p><b>62S11-N2-P</b> Fabricants: Grayhill, Inc. La description: ROTARY ENCODER OPTICAL 32PPR En stock: 2376 pcs</p> <p><a href="#">RFQ</a></p>

Copyright © 2020 Distributeur fiable de composants électroniques

Email: Info@infinity-electronic.com

Adresse: 17F, bâtiment commercial Gaylord, 114-118 Lockhart Road, Wan Chai, Hong Kong

