





Grayhill, Inc.

62S11-N4-025CH

Numéro d'article:	62S11-N4-025CH
Fabricant / marque:	Grayhill, Inc.
Description du produit:	ROTARY ENCODER OPTICAL 32PPR
Feuilles de données:	 62S11-N4-025CH.pdf
Statut RoHS	 Sans plomb / Conforme RoHS
Etat du stock	1946 pcs stock
Bateau de	Hong Kong
Manière d'expédition	DHL/Fedex/TNT/UPS/EMS

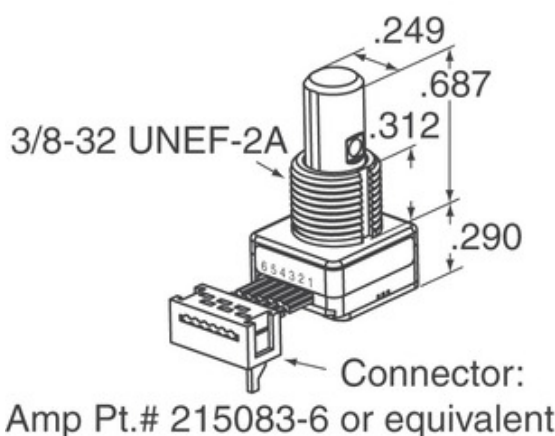

L'image peut être une représentation. Voir les spécifications pour les détails du produit.

[DEMANDE DE DEVIS](#)





Spécifications de 62S11-N4-025CH

NUMÉRO D'ARTICLE	62S11-N4-025CH
FABRICANT	Grayhill, Inc.
LA DESCRIPTION	ROTARY ENCODER OPTICAL 32PPR
ÉTAT SANS PLOMB / ÉTAT ROHS	Sans plomb / Conforme RoHS
QUANTITÉ DISPONIBLE	1946 pcs
FICHE TECHNIQUE	 62S11-N4-025CH.pdf
TENSION - ALIMENTATION	5V
STYLE DE RACCORDEMENT	Cable with Connector
SÉRIES	62S
VIE ROTATIONAL (CYCLES MIN)	1M
IMPULSIONS PAR TOUR	32
LE TYPE DE SORTIE	Quadrature (Incremental)
AUTRES NOMS	62S11N4025CH
ORIENTATION	Vertical
TYPE DE MONTAGE	Panel Mount
NIVEAU DE SENSIBILITÉ À L'HUMIDITÉ (MSL)	1 (Unlimited)
STATUT SANS PLOMB / STATUT ROHS	Lead free / RoHS Compliant
TYPE DE CODEUR	Optical
DETENT	No
COMMUTATEUR INTÉGRÉ	Yes
TYPE D'ACTIONNEUR	1/4" Dia Flatted End

Tags associés

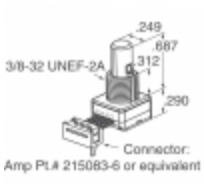
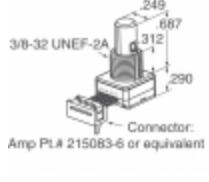
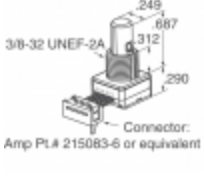
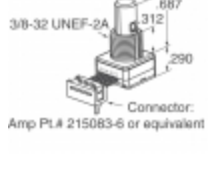
Grayhill, Inc. 62S11-N4-025CH	Distributeur 62S11-N4-025CH	62S11-N4-025CH Fournisseur
Prix 62S11-N4-025CH	62S11-N4-025CH Photos	Image 62S11-N4-025CH
62S11-N4-025CH PDF Fiche technique	62S11-N4-025CH Télécharger la fiche technique	62S11-N4-025CH Fiche technique
Action 62S11-N4-025CH	Acheter 62S11-N4-025CH	Acheter Grayhill, Inc. 62S11-N4-025CH
Grayhill, Inc. 62S11-N4-025CH	Grayhill, Inc. Fournisseur	Distributeur Grayhill, Inc.
Grayhill, Inc. 62S11-N4-025CH	Grayhill Inc. 62S11-N4-025CH	

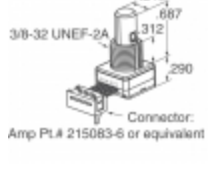
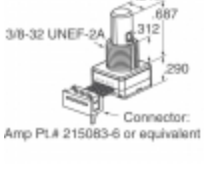
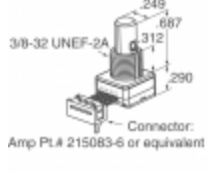
Produits connexes

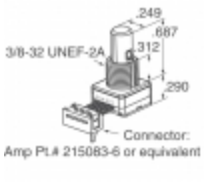
 <p>62S11-N4-025C Fabricants: Grayhill, Inc. La description: ROTARY ENCODER OPTICAL 32PPR En stock: 1970 pcs</p> <p>RFQ</p>	 <p>62S11-N4-120S Fabricants: Grayhill, Inc. La description: ROTARY ENCODER OPTICAL 32PPR En stock: 2038 pcs</p> <p>RFQ</p>
 <p>62S11-N3-PH Fabricants: Grayhill, Inc. La description: ROTARY ENCODER OPTICAL 32PPR En stock: 1856 pcs</p> <p>RFQ</p>	 <p>62S11-N2-P Fabricants: Grayhill, Inc. La description: ROTARY ENCODER OPTICAL 32PPR En stock: 2376 pcs</p> <p>RFQ</p>
 <p>62S11-N4-PH Fabricants: Grayhill, Inc. La description: ROTARY ENCODER OPTICAL 32PPR En stock: 1970 pcs</p> <p>RFQ</p>	 <p>62S11-N4-020C Fabricants: Grayhill, Inc. La description: ROTARY ENCODER OPTICAL 32PPR En stock: 2083 pcs</p> <p>RFQ</p>
 <p>62S11-N2-040C Fabricants: Grayhill, Inc. La description: ROTARY ENCODER OPTICAL 32PPR En stock: 2333 pcs</p> <p>RFQ</p>	 <p>62S11-N2-PH Fabricants: Grayhill, Inc. La description: ROTARY ENCODER OPTICAL 32PPR En stock: 1760 pcs</p> <p>RFQ</p>
 <p>62S11-N4-060SH Fabricants: Grayhill, Inc. La description: ROTARY ENCODER OPTICAL 32PPR En stock: 2262 pcs</p> <p>RFQ</p>	 <p>62S11-N5-025C Fabricants: Grayhill, Inc. La description: ROTARY ENCODER OPTICAL 32PPR En stock: 2408 pcs</p> <p>RFQ</p>
 <p>62S11-N5-025CH Fabricants: Grayhill, Inc. La description: ROTARY ENCODER OPTICAL 32PPR En stock: 2083 pcs</p> <p>RFQ</p>	 <p>62S11-N4-P Fabricants: Grayhill, Inc. La description: ROTARY ENCODER OPTICAL 32PPR En stock: 1912 pcs</p> <p>RFQ</p>