





Grayhill, Inc.

62S11-N4-PH

Número d'article:	62S11-N4-PH
Fabricant / marque:	Grayhill, Inc.
Description du produit:	ROTARY ENCODER OPTICAL 32PPR
Feuilles de données:	 62S11-N4-PH.pdf
Statut RoHS	 Sans plomb / Conforme RoHS
Etat du stock	1970 pcs stock
Bateau de	Hong Kong
Manière d'expédition	DHL/Fedex/TNT/UPS/EMS

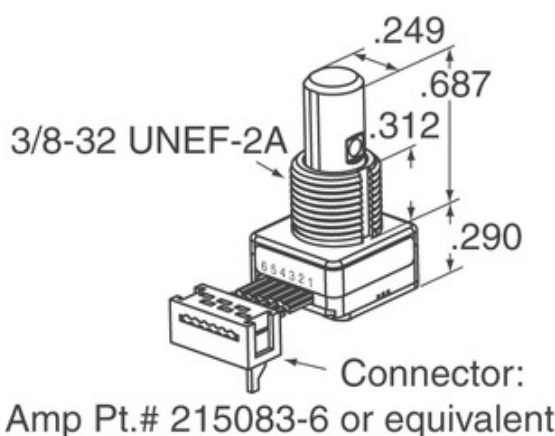
[DEMANDE DE DEVIS](#)

L'image peut être une représentation. Voir les spécifications pour les détails du produit.







Spécifications de 62S11-N4-PH

NUMÉRO D'ARTICLE	62S11-N4-PH
FABRICANT	Grayhill, Inc.
LA DESCRIPTION	ROTARY ENCODER OPTICAL 32PPR
ÉTAT SANS PLOMB / ÉTAT ROHS	Sans plomb / Conforme RoHS
QUANTITÉ DISPONIBLE	1970 pcs
FICHE TECHNIQUE	 62S11-N4-PH.pdf
TENSION - ALIMENTATION	5V
STYLE DE RACCORDEMENT	PC Pin
SÉRIES	62S
VIE ROTATIONAL (CYCLES MIN)	1M
IMPULSIONS PAR TOUR	32
LE TYPE DE SORTIE	Quadrature (Incremental)
AUTRES NOMS	62S11N4PH
ORIENTATION	Vertical
TYPE DE MONTAGE	PCB, Through Hole
NIVEAU DE SENSIBILITÉ À L'HUMIDITÉ (MSL)	1 (Unlimited)
STATUT SANS PLOMB / STATUT ROHS	Lead free / RoHS Compliant
TYPE DE CODEUR	Optical
DETENT	No
COMMUTATEUR INTÉGRÉ	Yes
TYPE D'ACTIONNEUR	1/4" Dia Flatted End

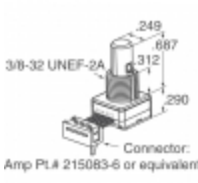
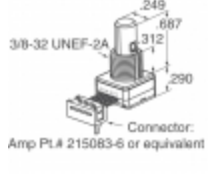
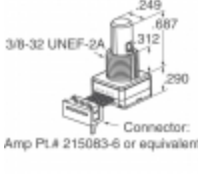
Tags associés

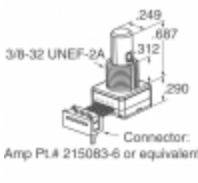
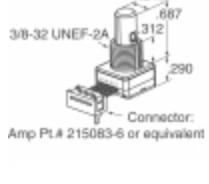
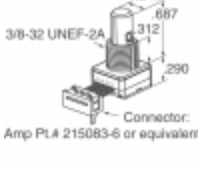
Grayhill, Inc. 62S11-N4-PH	Distributeur 62S11-N4-PH	62S11-N4-PH Fournisseur
Prix 62S11-N4-PH	62S11-N4-PH Photos	Image 62S11-N4-PH
62S11-N4-PH PDF Fiche technique	62S11-N4-PH Télécharger la fiche technique	62S11-N4-PH Fiche technique
Action 62S11-N4-PH	Acheter 62S11-N4-PH	Acheter Grayhill, Inc. 62S11-N4-PH
Grayhill, Inc. 62S11-N4-PH	Grayhill, Inc. Fournisseur	Distributeur Grayhill, Inc.
Grayhill, Inc. 62S11-N4-PH	Grayhill Inc. 62S11-N4-PH	

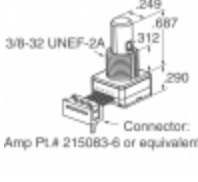
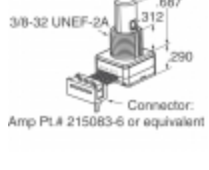
Produits connexes

 <p>62S11-N4-025C Fabricants: Grayhill, Inc. La description: ROTARY ENCODER OPTICAL 32PPR En stock: 1970 pcs</p> <p>RFQ</p>	 <p>62S11-N4-120S Fabricants: Grayhill, Inc. La description: ROTARY ENCODER OPTICAL 32PPR En stock: 2038 pcs</p> <p>RFQ</p>
 <p>62S11-N4-025CH Fabricants: Grayhill, Inc. La description: ROTARY ENCODER OPTICAL 32PPR En stock: 1946 pcs</p> <p>RFQ</p>	 <p>62S11-N5-060SH Fabricants: Grayhill, Inc. La description: ROTARY ENCODER OPTICAL 32PPR En stock: 2263 pcs</p> <p>RFQ</p>
 <p>62S11-N4-020C Fabricants: Grayhill, Inc. La description: ROTARY ENCODER OPTICAL 32PPR En stock: 2083 pcs</p> <p>RFQ</p>	 <p>62S11-N5-060C Fabricants: Grayhill, Inc. La description: ROTARY ENCODER OPTICAL 32PPR En stock: 2164 pcs</p> <p>RFQ</p>
 <p>62S11-N4-P Fabricants: Grayhill, Inc. La description: ROTARY ENCODER OPTICAL 32PPR En stock: 1912 pcs</p> <p>RFQ</p>	 <p>62S11-N5-050C Fabricants: Grayhill, Inc. La description: ROTARY ENCODER OPTICAL 32PPR En stock: 1936 pcs</p> <p>RFQ</p>
 <p>62S11-N5-025CH Fabricants: Grayhill, Inc. La description: ROTARY ENCODER OPTICAL 32PPR En stock: 2083 pcs</p> <p>RFQ</p>	 <p>62S11-N5-040C Fabricants: Grayhill, Inc. La description: ROTARY ENCODER OPTICAL 32PPR En stock: 2106 pcs</p> <p>RFQ</p>
 <p>62S11-N4-060SH Fabricants: Grayhill, Inc. La description: ROTARY ENCODER OPTICAL 32PPR En stock: 2262 pcs</p> <p>RFQ</p>	 <p>62S11-N5-025C Fabricants: Grayhill, Inc. La description: ROTARY ENCODER OPTICAL 32PPR En stock: 2408 pcs</p> <p>RFQ</p>

Copyright © 2020 Distributeur fiable de composants électroniques

Email: Info@infinity-electronic.com

Adresse: 17F, bâtiment commercial Gaylord, 114-118 Lockhart Road, Wan Chai, Hong Kong

