





Grayhill, Inc.

62S11-N0-020SH

Numéro d'article:	62S11-N0-020SH
Fabricant / marque:	Grayhill, Inc.
Description du produit:	ROTARY ENCODER OPTICAL 32PPR
Feuilles de données:	 62S11-N0-020SH.pdf
Statut RoHS	 Sans plomb / Conforme RoHS
Etat du stock	2229 pcs stock
Bateau de	Hong Kong
Manière d'expédition	DHL/Fedex/TNT/UPS/EMS

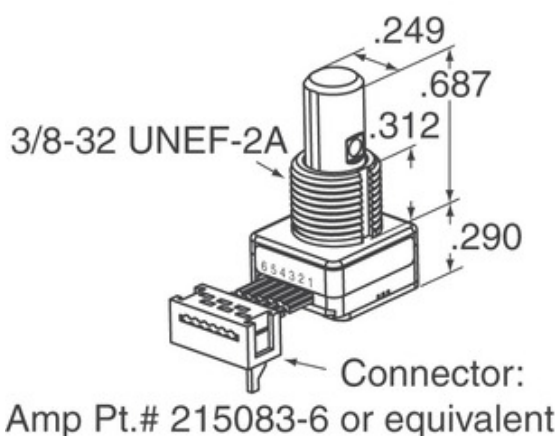

L'image peut être une représentation. Voir les spécifications pour les détails du produit.

[DEMANDE DE DEVIS](#)





Spécifications de 62S11-N0-020SH

NUMÉRO D'ARTICLE	62S11-N0-020SH
FABRICANT	Grayhill, Inc.
LA DESCRIPTION	ROTARY ENCODER OPTICAL 32PPR
ÉTAT SANS PLOMB / ÉTAT ROHS	Sans plomb / Conforme RoHS
QUANTITÉ DISPONIBLE	2229 pcs
FICHE TECHNIQUE	 62S11-N0-020SH.pdf
TENSION - ALIMENTATION	5V
STYLE DE RACCORDEMENT	Cable Leads
SÉRIES	62S
VIE ROTATIONAL (CYCLES MIN)	1M
IMPULSIONS PAR TOUR	32
LE TYPE DE SORTIE	Quadrature (Incremental)
AUTRES NOMS	62S11N0020SH
ORIENTATION	Vertical
TYPE DE MONTAGE	Panel Mount
NIVEAU DE SENSIBILITÉ À L'HUMIDITÉ (MSL)	1 (Unlimited)
STATUT SANS PLOMB / STATUT ROHS	Lead free / RoHS Compliant
TYPE DE CODEUR	Optical
DETENT	No
COMMUTATEUR INTÉGRÉ	No
TYPE D'ACTIONNEUR	1/4" Dia Flatted End

Tags associés

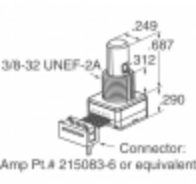
Grayhill, Inc. 62S11-N0-020SH	Distributeur 62S11-N0-020SH	62S11-N0-020SH Fournisseur
Prix 62S11-N0-020SH	62S11-N0-020SH Photos	Image 62S11-N0-020SH
62S11-N0-020SH PDF Fiche technique	62S11-N0-020SH Télécharger la fiche technique	62S11-N0-020SH Fiche technique
Action 62S11-N0-020SH	Acheter 62S11-N0-020SH	Acheter Grayhill, Inc. 62S11-N0-020SH
Grayhill, Inc. 62S11-N0-020SH	Grayhill, Inc. Fournisseur	Distributeur Grayhill, Inc.
Grayhill, Inc. 62S11-N0-020SH	Grayhill Inc. 62S11-N0-020SH	

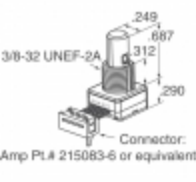
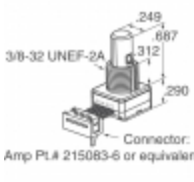
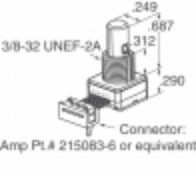
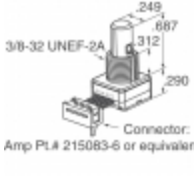
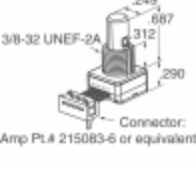
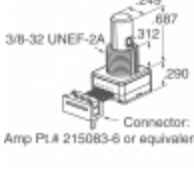
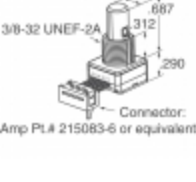
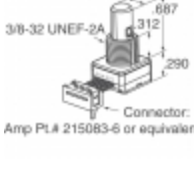
Produits connexes

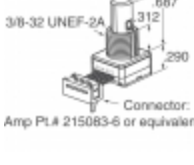
 <p>62S11-N0-020S Fabricants: Grayhill, Inc. La description: ROTARY ENCODER OPTICAL 32PPR En stock: 2261 pcs</p> <p>RFQ</p>	 <p>62S11-N0-040CH Fabricants: Grayhill, Inc. La description: ROTARY ENCODER OPT 32PPR 4" CBL En stock: 2486 pcs</p> <p>RFQ</p>
 <p>62S11-M9-PH Fabricants: Grayhill, Inc. La description: ROTARY ENCODER OPTICAL 32PPR En stock: 1744 pcs</p> <p>RFQ</p>	 <p>62S11-N0-PH Fabricants: Grayhill, Inc. La description: ROTARY ENCODER OPTICAL 32PPR En stock: 2260 pcs</p> <p>RFQ</p>
 <p>62S11-N0-040S Fabricants: Grayhill, Inc. La description: ROTARY ENCODER OPTICAL 32PPR En stock: 1981 pcs</p> <p>RFQ</p>	 <p>62S11-N0-020C Fabricants: Grayhill, Inc. La description: ROTARY ENCODER OPTICAL 32PPR En stock: 1781 pcs</p> <p>RFQ</p>
 <p>62S11-N0-P Fabricants: Grayhill, Inc. La description: ROTARY ENCODER OPTICAL 32PPR En stock: 2285 pcs</p> <p>RFQ</p>	 <p>62S11-N0-020CH Fabricants: Grayhill, Inc. La description: ROTARY ENCODER OPTICAL 32PPR En stock: 2062 pcs</p> <p>RFQ</p>
 <p>62S11-M9-P Fabricants: Grayhill, Inc. La description: ROTARY ENCODER OPTICAL 32PPR En stock: 1799 pcs</p> <p>RFQ</p>	 <p>62S11-M9-120S Fabricants: Grayhill, Inc. La description: ROTARY ENCODER OPTICAL 32PPR En stock: 2092 pcs</p> <p>RFQ</p>
 <p>62S11-N0-050C Fabricants: Grayhill, Inc. La description: ROTARY ENCODER OPTICAL 32PPR En stock: 2346 pcs</p> <p>RFQ</p>	 <p>62S11-N0-040C Fabricants: Grayhill, Inc. La description: ROTARY ENCODER OPT 32PPR 4" CBL En stock: 1995 pcs</p> <p>RFQ</p>

Copyright © 2020 Distributeur fiable de composants électroniques

Email: Info@infinity-electronic.com

Adresse: 17F, bâtiment commercial Gaylord, 114-118 Lockhart Road, Wan Chai, Hong Kong

