

THIS DOCUMENT IS THE PROPERTY OF
KEYSTONE ELECTRONICS CORP. AND
SHALL NOT BE REPRODUCED, DISTRIBUTED
OR USED AS A BASIS FOR MANUFACTURE
WITHOUT PRIOR WRITTEN PERMISSION
FROM KEYSTONE ELECTRONICS CORP.

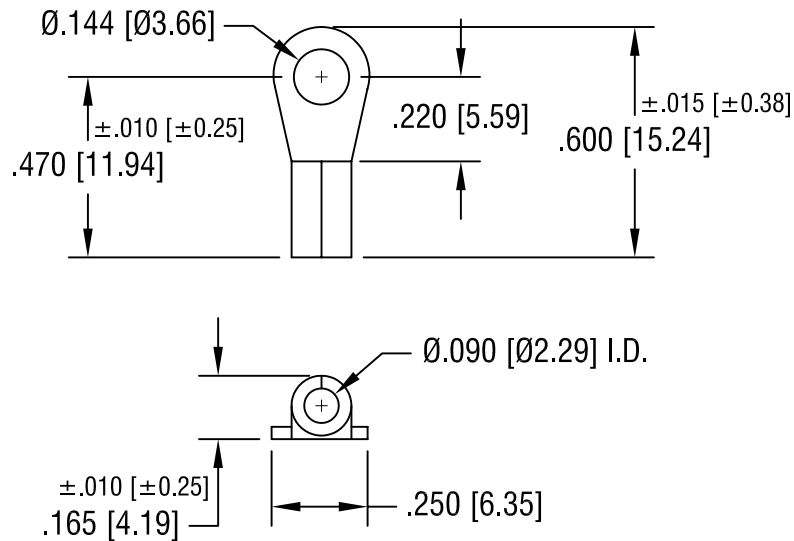

NOTE:

1. ACCOMMODATES WIRE RANGE 16/14 AWG

KEYSTONE ELECTRONICS CORP.			
ASTORIA, N.Y. 11105-2017			
PART NAME			
RING TONGUE TERMINAL			
MATERIAL			
.030 [0.76] TH'K COPPER			
FINISH		DRN BY	DATE
TIN PLATE		BOONE	10.17.07
		APP'D	SCALE
		LN	2X
TOLERANCES		INCH	[MM]
DECIMAL		$\pm .005$	[± 0.15]
ANGULAR		$\pm 1^\circ$	
UNLESS OTHERWISE SPECIFIED		CODE	DWG NO.
		C/M	8203

DATE	DESCRIPTION	REV.