

DESIGN A PRACTICAL DESK LAMP WITH THIS

5V LED Desk Lamp Kit

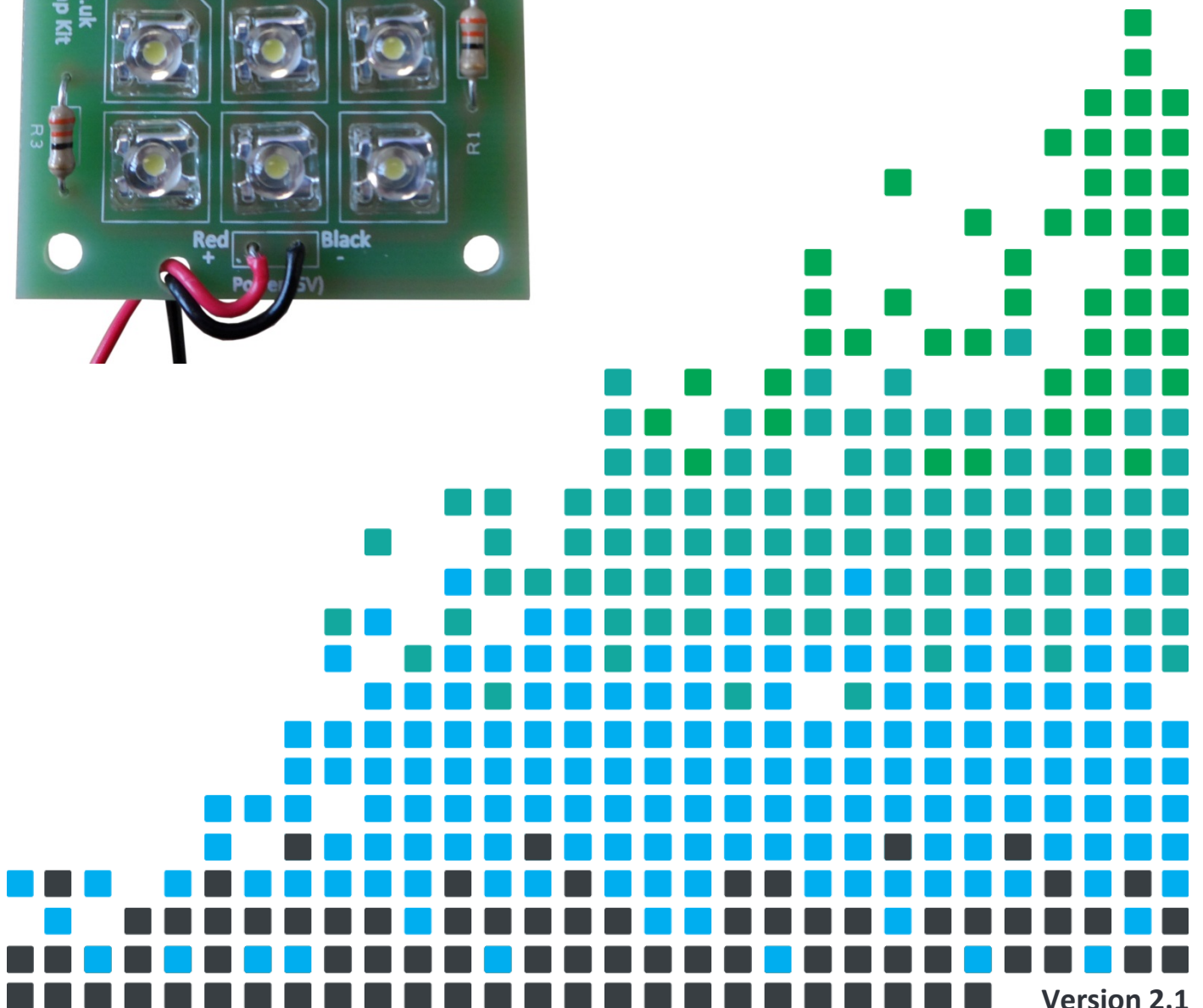
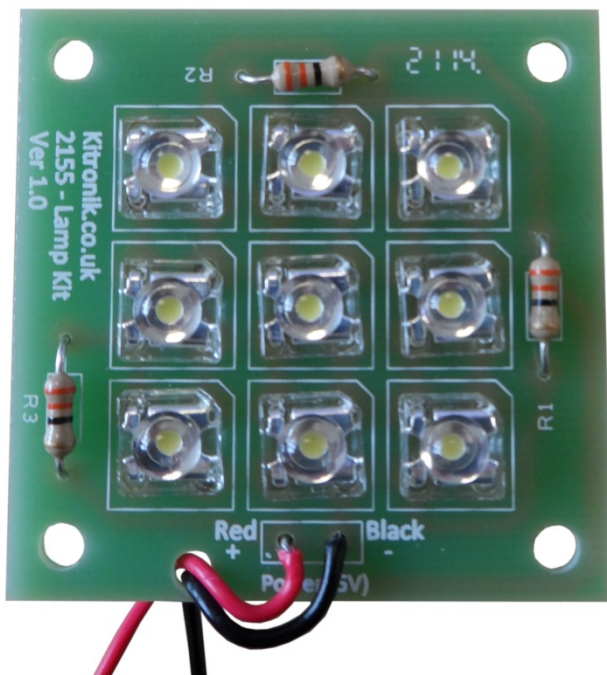

Build Instructions

Before you start, take a look at the Printed Circuit Board (PCB). The components go in the side with the writing on and the solder goes on the side with the tracks and silver pads.

1

PLACE THE RESISTORS

Start with the resistors R1, R2 and R3. All three are the same so it does not matter which one goes where. It also does not matter which way around they go.



2

PLACE THE LEDs

The LEDs all have a corner 'missing'. Line up this missing corner with the component outline on the PCB. This will ensure that they are the correct way around. All nine of the LEDs are the same and it does not matter which one goes where.

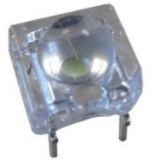

3

ATTACH POWER

Attach your preferred 5V power supply (not included in the kit). Thread both wires through the stress relief hole first then solder the positive wire to the pad labelled 'Red' marked with a '+'. Finally, solder the negative wire to the pad labelled 'black' and marked with a '-'.



Checking Your 5V LED Desk Lamp PCB

- Is the positive '+' pad on the PCB connected to the positive wire on your 5V power supply?
- Is the negative '-' pad on the PCB wired to the negative wire on your 5V power supply?
- Have you soldered all the components in? There should be no unused component holes. Only the four mounting holes should be empty.
- Is the LED orientation correct? (Does the outline of the LED match the markings on the PCB?)

Fault finding flow chart

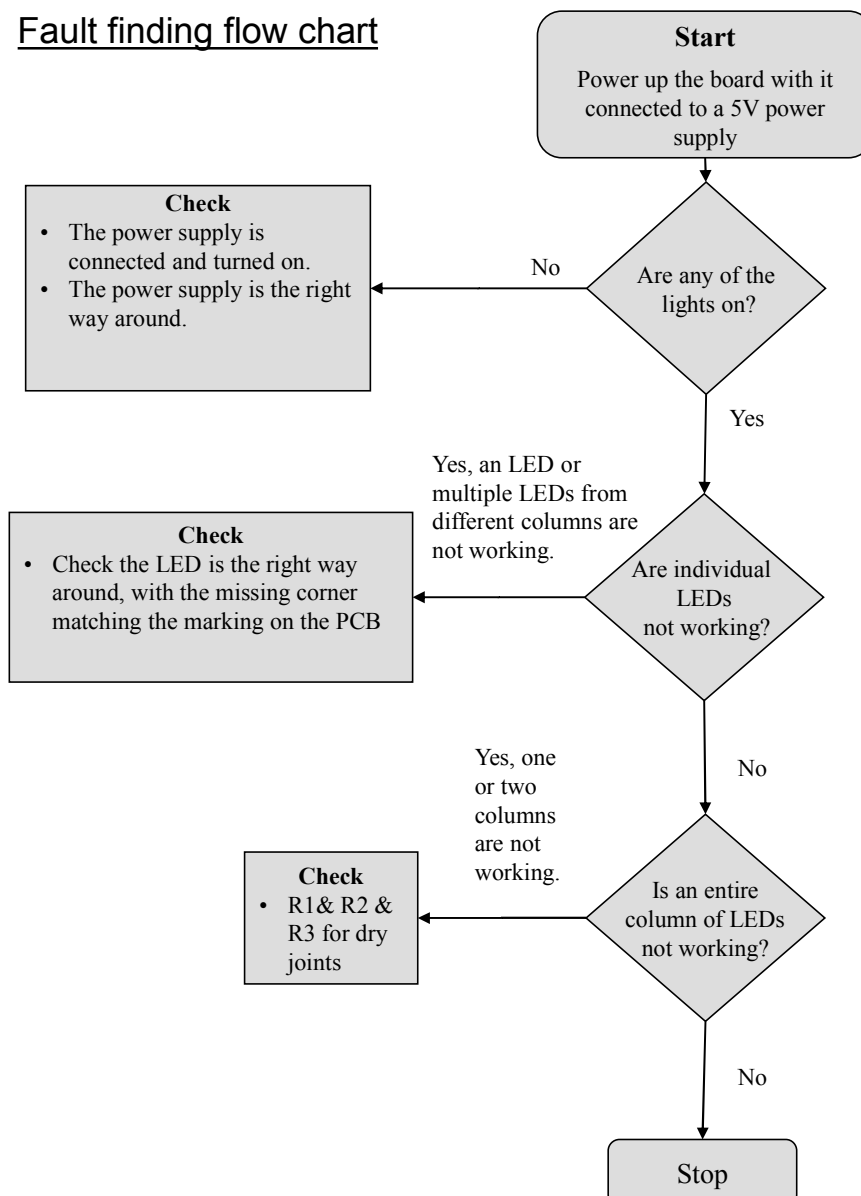

Adding an On / Off Switch

1

If you wish to add a power switch, cut one of the power wires leading to your 5V LED Desk Lamp PCB. Don't cut too close to the PCB or it will be difficult to reach the switch.



2

Strip the two ends that were made when you cut the wire.

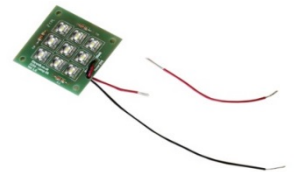

3

Solder the newly stripped wire to the switch. One piece to each terminal.



Designing the Enclosure

When you design the enclosure, you will need to consider:

- The size of the PCB (below).
- Where the power cable comes out.
- There are four 3.3mm holes in the corners of the PCB to secure the PCB in the enclosure.

This technical drawing of the built 5V LED Desk Lamp PCB should help you to design your enclosure. The total height of the assembled unit is 9mm.

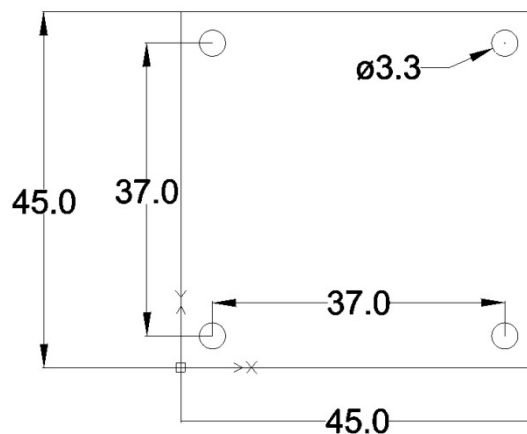

(Dimensions in mm)

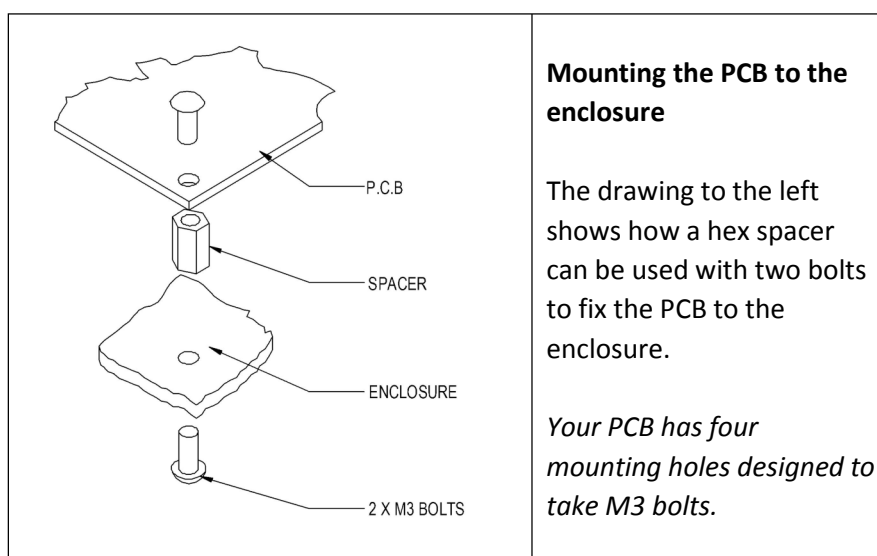

How the 5V LED Desk Lamp Works

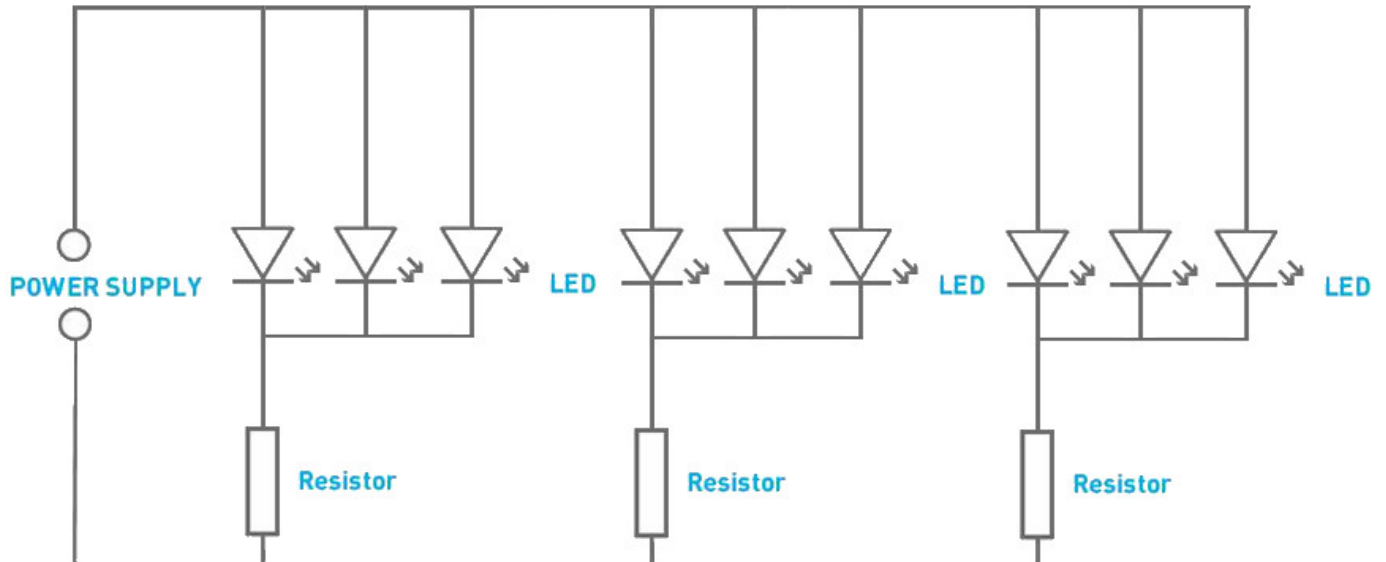

The circuit diagram for the 5V LED Desk Lamp is shown above. It is a very simple circuit. The board contains nine LEDs, these are grouped in to threes, with each group of three sharing a current limit resistor.

LEDs can be damaged if too much current goes through them so a 33 Ohm resistor is on each 'branch'. This allows around 20mA to each LED or 60mA per branch.



Online Information

Two sets of information can be downloaded from the product page where the kit can also be reordered from. The 'Essential Information' contains all of the information that you need to get started with the kit and the 'Teaching Resources' contains more information on soldering, components used in the kit, educational schemes of work and so on and also includes the essentials. Download from:

www.kitronik.co.uk/2155



This kit is designed and manufactured in the UK by Kitronik

Telephone: +44 (0) 845 8380781

Sales email: sales@kitronik.co.uk

Tech support email: support@kitronik.co.uk

Web: www.kitronik.co.uk



www.kitronik.co.uk/twitter



www.kitronik.co.uk/facebook



www.kitronik.co.uk/youtube



www.kitronik.co.uk/google

Every effort has been made to ensure that these notes are correct, however Kitronik accept no responsibility for issues arising from errors / omissions in the notes.

© Kitronik Ltd - Any unauthorised copying / duplication of this booklet or part thereof for purposes except for use with Kitronik project kits is not allowed without Kitronik's prior consent.

