

BK PRECISION®

9200 Series Multi-Range DC Power Supply

Models: 9201, 9202, 9205, 9206

USER MANUAL



Safety Summary

The following safety precautions apply to both operating and maintenance personnel and must be followed during all phases of operation, service, and repair of this instrument.

WARNING

Before applying power to this instrument:

- Read and understand the safety and operational information in this manual.
- Apply all the listed safety precautions.
- Verify that the voltage selector at the line power cord input is set to the correct line voltage. Operating the instrument at an incorrect line voltage will void the warranty.
- Make all connections to the instrument before applying power.
- Do not operate the instrument in ways not specified by this manual or by B&K Precision.

Failure to comply with these precautions or with warnings elsewhere in this manual violates the safety standards of design, manufacture, and intended use of the instrument. B&K Precision assumes no liability for a customer's failure to comply with these requirements.

Category rating

The IEC 61010 standard defines safety category ratings that specify the amount of electrical energy available and the voltage impulses that may occur on electrical conductors associated with these category ratings. The category rating is a Roman numeral of I, II, III, or IV. This rating is also accompanied by a maximum voltage of the circuit to be tested, which defines the voltage impulses expected and required insulation clearances. These categories are:

Category I (CAT I): Measurement instruments whose measurement inputs are not intended to be connected to the mains supply. The voltages in the environment are typically derived from a limited-energy transformer or a battery.

Category II (CAT II): Measurement instruments whose measurement inputs are meant to be connected to the mains supply at a standard wall outlet or similar sources. Example measurement environments are portable tools and household appliances.

Category III (CAT III): Measurement instruments whose measurement inputs are meant to be connected to the mains installation of a building. Examples are measurements inside a building's circuit breaker panel or the wiring of permanently-installed motors.

Category IV (CAT IV): Measurement instruments whose measurement inputs are meant to be connected to the primary power entering a building or other outdoor wiring.

WARNING

Do not use this instrument in an electrical environment with a higher category rating than what is specified in this manual for this instrument.

⚠️ WARNING

You must ensure that each accessory you use with this instrument has a category rating equal to or higher than the instrument's category rating to maintain the instrument's category rating. Failure to do so will lower the category rating of the measuring system.

Electrical Power

This instrument is intended to be powered from a CATEGORY II mains power environment. The mains power should be 120 V RMS or 240 V RMS. Use only the power cord supplied with the instrument and ensure it is appropriate for your country of use.

Ground the Instrument

⚠️ WARNING

To minimize shock hazard, the instrument chassis and cabinet must be connected to an electrical safety ground. This instrument is grounded through the ground conductor of the supplied, three-conductor AC line power cable. The power cable must be plugged into an approved three-conductor electrical outlet. The power jack and mating plug of the power cable meet IEC safety standards.

⚠️ WARNING

Do not alter or defeat the ground connection. Without the safety ground connection, all accessible conductive parts (including control knobs) may provide an electric shock. Failure to use a properly-grounded approved outlet and the recommended three-conductor AC line power cable may result in injury or death.

⚠️ WARNING

Unless otherwise stated, a ground connection on the instrument's front or rear panel is for a reference of potential only and is not to be used as a safety ground.

Do not operate in an explosive or flammable atmosphere

⚠️ WARNING

Do not operate the instrument in the presence of flammable gases or vapors, fumes, or finely-divided particulates.

⚠️ WARNING

The instrument is designed to be used in office-type indoor environments. Do not operate the instrument

- In the presence of noxious, corrosive, or flammable fumes, gases, vapors, chemicals, or finely-divided particulates.
- In relative humidity conditions outside the instrument's specifications.
- In environments where there is a danger of any liquid being spilled on the instrument or where any liquid can condense on the instrument.

- In air temperatures exceeding the specified operating temperatures.
- In atmospheric pressures outside the specified altitude limits or where the surrounding gas is not air.
- In environments with restricted cooling air flow, even if the air temperatures are within specifications.
- In direct sunlight.

CAUTION

This instrument is intended to be used in an indoor pollution degree 2 environment. The operating temperature range is 0 °C to 40 °C and the operating humidity range is up to 80% relative humidity with no condensation allowed.

Measurements made by this instrument may be outside specifications if the instrument is used in non-office-type environments. Such environments may include rapid temperature or humidity changes, sunlight, vibration and/or mechanical shocks, acoustic noise, electrical noise, strong electric fields, or strong magnetic fields.

Do not operate instrument if damaged

WARNING

If the instrument is damaged, appears to be damaged, or if any liquid, chemical, or other material gets on or inside the instrument, remove the instrument's power cord, remove the instrument from service, label it as not to be operated, and return the instrument to B&K Precision for repair. Notify B&K Precision of the nature of any contamination of the instrument.

Clean the instrument only as instructed

WARNING

Do not clean the instrument, its switches, or its terminals with contact cleaners, abrasives, lubricants, solvents, acids/bases, or other such chemicals. Clean the instrument only with a clean dry lint-free cloth or as instructed in this manual.

Not for critical applications

WARNING

This instrument is not authorized for use in contact with the human body or for use as a component in a life-support device or system.

Do not touch live circuits

WARNING

Instrument covers must not be removed by operating personnel. Component replacement and internal adjustments must be made by qualified service-trained maintenance personnel who are aware of the hazards involved when the instrument's covers and shields are removed.

Under certain conditions, even with the power cord removed, dangerous voltages may exist when the covers are removed. To avoid injuries, always disconnect the power cord from the instrument, disconnect all other connections (for example, test leads, computer interface cables, etc.), discharge all circuits, and verify there are no hazardous voltages present on any conductors by measurements with a properly-operating voltage-sensing device before touching any internal parts. Verify the voltage-sensing device is working properly before and after making the measurements by testing with known-operating voltage sources and test for both DC and AC voltages. Do not attempt any service or adjustment unless another person capable of rendering first aid and resuscitation is present.

Do not insert any object into an instrument's ventilation openings or other openings.

WARNING

Hazardous voltages may be present in unexpected locations in circuitry being tested when a fault condition in the circuit exists.

Fuse replacement

WARNING

Fuse replacement must be done by qualified service-trained maintenance personnel who are aware of the instrument's fuse requirements and safe replacement procedures. Disconnect the instrument from the power line before replacing fuses. Replace fuses only with new fuses of the fuse types, voltage ratings, and current ratings specified in this manual or on the back of the instrument. Failure to do so may damage the instrument, lead to a safety hazard, or cause a fire. Failure to use the specified fuses will void the warranty.

Servicing

CAUTION

Do not substitute parts that are not approved by B&K Precision or modify this instrument. Return the instrument to B&K Precision for service and repair to ensure that safety and performance features are maintained.

Cooling fans

CAUTION

This instrument contains one or more cooling fans. For continued safe operation of the instrument, the air inlet and exhaust openings for these fans must not be blocked nor must accumulated dust or other debris be allowed to reduce air flow. Maintain at least 25 mm clearance around the sides of the instrument that contain air inlet and exhaust ports. If mounted in a rack, position power devices in the rack above the instrument to minimize instrument heating while rack mounted. Do not continue to operate the instrument if you cannot verify the fan is operating (note some fans may have intermittent duty cycles). Do not insert any object into the fan's inlet or outlet.

Use correctly sized wires

 **WARNING**

To connect a load to the power supply, use a wire diameter large enough to handle the maximum continuous output short-circuit current of the power supply without the wire overheating.

For continued safe use of the instrument

- Do not place heavy objects on the instrument.
- Do not obstruct cooling air flow to the instrument.
- Do not place a hot soldering iron on the instrument.
- Do not pull the instrument with the power cord, connected probe, or connected test lead.
- Do not move the instrument when a probe is connected to a circuit being tested.

Compliance Statements

Disposal of Old Electrical & Electronic Equipment (Applicable in the European Union and other European countries with separate collection systems)

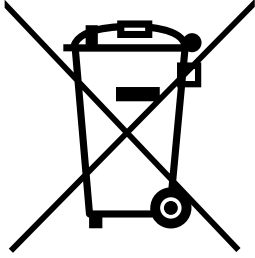

This product is subject to Directive 2002/96/EC of the European Parliament and the Council of the European Union on waste electrical and electronic equipment (WEEE), and in jurisdictions adopting that Directive, is marked as being put on the market after August 13, 2005, and should not be disposed of as unsorted municipal waste. Please utilize your local WEEE collection facilities in the disposition of this product and otherwise observe all applicable requirements.

CE Declaration of Conformity

This instrument meets the requirements of 2006/95/EC Low Voltage Directive and 2004/108/EC Electromagnetic Compatibility Directive with the following standards.

Low Voltage Directive

- EN61010-1: 2001

EMC Directive

- EN 61000-3-2: 2006
- EN 61000-3-3: 1995+A1: 2001+A2: 2005
- EN 61000-4-2 / -3 / -4 / -5 / -6 / -11
- EN 61326-1: 2006

Safety Symbols













	Refer to the user manual for warning information to avoid hazard or personal injury and prevent damage to instrument.
	Electric Shock hazard
	On (Supply). This is the AC mains connect/disconnect switch on the front of the instrument.
	Off (Supply). This is the AC mains connect/disconnect switch on the front of the instrument.
	Direct current
	Alternating current
	Fuse Symbol
	Chassis (earth ground) symbol
	Ground terminal
	Protective earth ground
	CAUTION indicates a hazardous situation which, if not avoided, will result in minor or moderate injury
	WARNING indicates a hazardous situation which, if not avoided, could result in death or serious injury
	DANGER indicates a hazardous situation which, if not avoided, will result in death or serious injury.

Table of Contents

Safety Summary	ii
Compliance Statements	vii
Safety Symbols	ix
1 General Information	1
1.1 Product Overview	1
1.2 Package Contents	1
1.3 Product Dimensions	2
1.4 Rackmount Installation	2
1.5 Front Panel Overview	4
<i>Front Panel Description</i>	4
1.6 Keypad Overview	5
<i>Keypad Description</i>	5
1.7 Rear Panel Overview	6
<i>Rear Panel Description</i>	6
1.8 Display Overview	7
<i>Display Description</i>	7
2 Getting Started	8
2.1 Input Power and Fuse Requirements	8
<i>Input Power</i>	8
<i>Fuse Requirements</i>	9
2.2 Line Voltage Selection	9
2.3 Output Connections	11
2.4 Preliminary Check	12
<i>Self-test Errors</i>	12
<i>Output Check</i>	12
<i>Check Model and Firmware Version</i>	13
3 Front Panel Operation	14
3.1 Menu Options	14
<i>How to Access the Menu</i>	14

3.2	Configure Voltage and Current Output	15
	<i>Setting Voltage</i>	15
	<i>Setting Current</i>	16
	<i>Remote Sense</i>	16
3.3	Voltage/Current Measurement	18
3.4	SYSTEM Menu	18
	<i>Voltage Limit Setting</i>	18
	<i>Configure Overcurrent Protection (OCP)</i>	19
	<i>Configure Power-On State</i>	19
	<i>Remote Communication Configuration</i>	19
	<i>Enable/Disable Key Sound</i>	19
	<i>Lock/Unlock Rotary Knob</i>	20
	<i>Configure Trigger Source</i>	20
	<i>Save/Recall Instrument Settings</i>	20
	<i>Timer Function</i>	21
	<i>Restore Factory Default Settings</i>	22
3.5	LIST Menu	23
	<i>Enable/Disable List Mode</i>	23
	<i>Load List File</i>	24
	<i>Edit List File</i>	24
3.6	Overvoltage Protection (OVP)	25
3.7	Key Lock	25
3.8	Digital Voltmeter (DVM)	26
4	Remote Operation	27
4.1	Interface Configuration	27
	<i>RS-232</i>	27
	<i>USB</i>	28
	<i>GPIB</i>	29
5	Remote Commands	29
5.1	Parameter Definition	29
5.2	SCPI Status Register	30
5.3	IEEE488.2 Common Commands	33

5.4	STATUS Subsystem	35
5.5	SYSTEM Subsystem	36
5.6	TRIGGER Subsystem	39
5.7	SOURCE Subsystem	39
5.8	MEASUREMENT Commands.....	43
5.9	LIST Commands	45
6	Troubleshooting Guide	47
	<i>General</i>	47
	<i>Remote Control</i>	47
7	Specifications	48
8	Calibration.....	49
	SERVICE INFORMATION.....	50
	LIMITED THREE-YEAR WARRANTY	51

1 General Information

1.1 Product Overview

The 9200 Series power supplies are multi-range single-output DC power supplies capable of replacing several supplies on the bench. Unlike conventional supplies with fixed output ratings, these multi-range power supplies automatically re-calculate voltage and current limits for each setting, providing full output power in any Volt/Amp combination within the rated voltage and current limits. Each model in the 9200 Series comes standard with USB, GPIB, and RS-232 communication interfaces for remote control.

Features:

- High visibility VFD display
- Easy-to-use interface with numerical keypad, cursors, and rotary control knobs
- High programming and readback resolution
- Low ripple and noise
- Intelligent fan control
- List mode programming
- Standard USB, GPIB, and RS-232 interfaces
- Software for remote control
- SCPI-compliant command set
- Output timer function
- Overvoltage protection (OVP), overcurrent protection (OCP), and overtemperature protection (OTP)

1.2 Package Contents

Please inspect the instrument mechanically and electrically upon receiving it. Unpack all items from the shipping carton, and check for any obvious signs of physical damage that may have occurred during transportation. Report any damage to the shipping agent immediately. Save the original packing carton for possible future reshipment. Every power supply is shipped with the following contents:

- **1 x 9201, 9202, 9205, or 9206 Power Supply**
- **1 x User Manual**
- **1 x AC Power Cord**
- **1 x Certificate of Calibration**
- **1 x Test Report**

Verify that all items above are included in the shipping container. If anything is missing, please contact B&K Precision.

1.3 Product Dimensions

The 9201 and 9202 power supply's dimensions are approximately 214.5 mm (8.44 in) x 88.2 mm (3.47 in) x 354.6 mm (13.96 in) (W x H x D). The 9205 and 9206 power supply's dimensions are approximately 214.5 mm (8.44 in) x 88.2 mm (3.47 in) x 445 mm (17.52 in) (W x H x D).

Note: All dimensions in the figures below are measured in millimeters (mm).

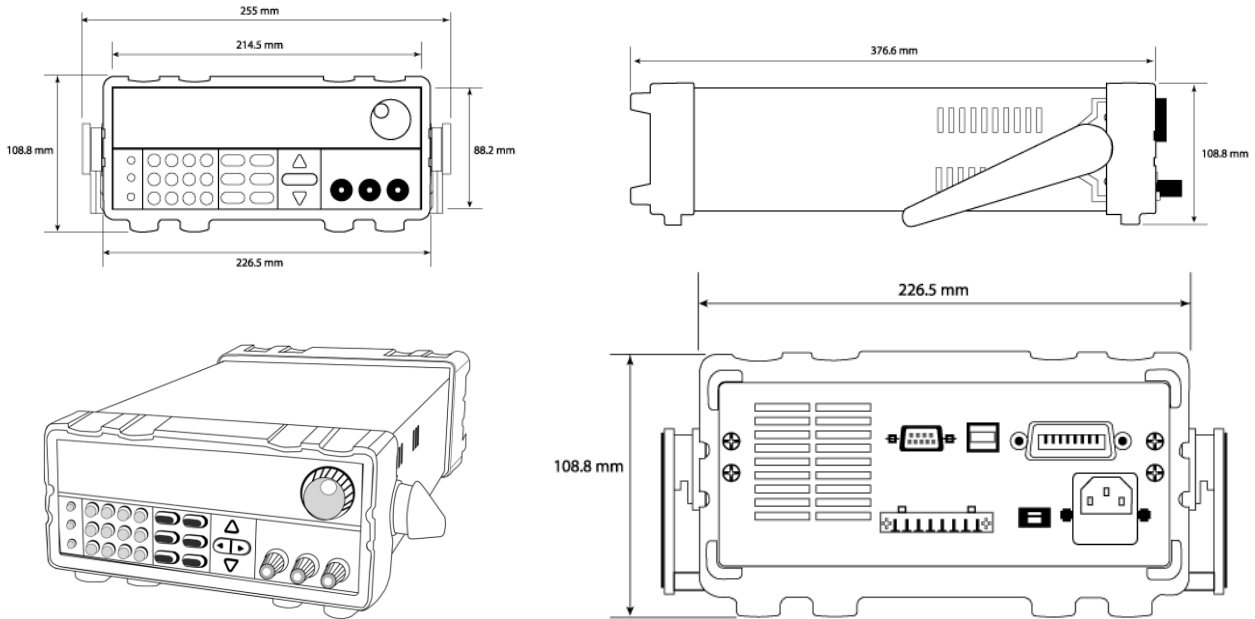

1.4 Rackmount Installation

The instrument can be installed in a standard 19-inch rack using the optional IT-E151 rackmount kit. Below is an image of a 9200 Series model installed with the IT-E151 rackmount kit.

Note: Remove the carrying handle and the two plastic ears before mounting the instrument. To remove the handle, grasp the handle by its sides, pull outwards, and rotate it until the arrow on the handle and the arrow on the plastic ears are in opposite directions. Then pull the handle outward. After removing the handle, you can use a screwdriver to remove the two plastic ears.

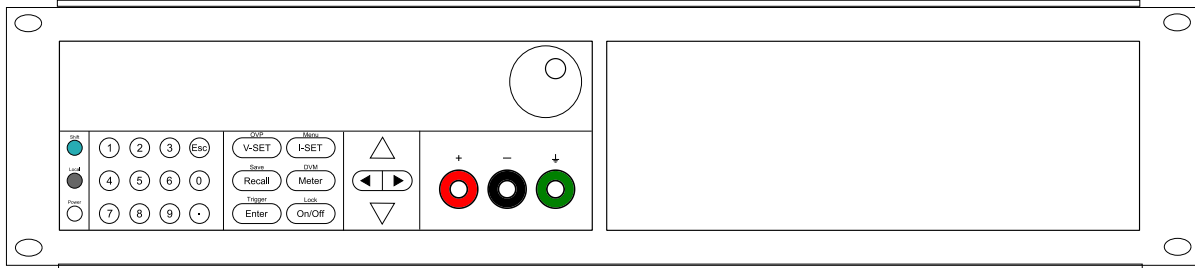

To rackmount a single instrument, order rackmount kit IT-E151

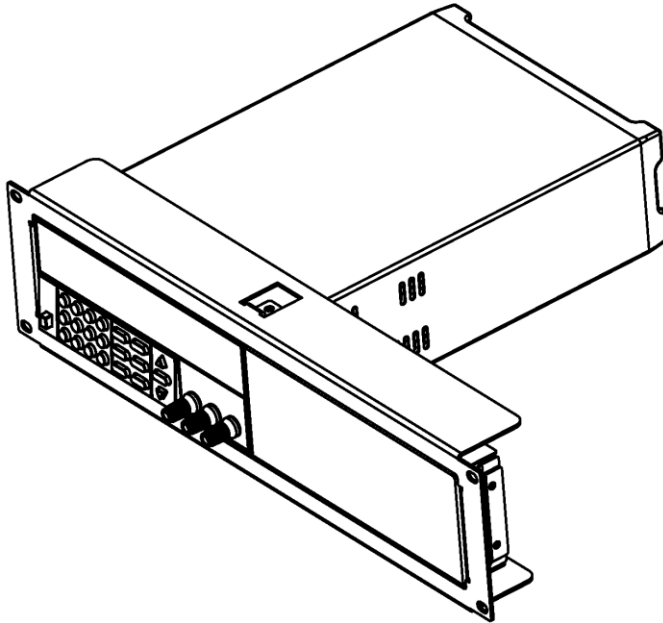

Side view of rackmounting a single instrument

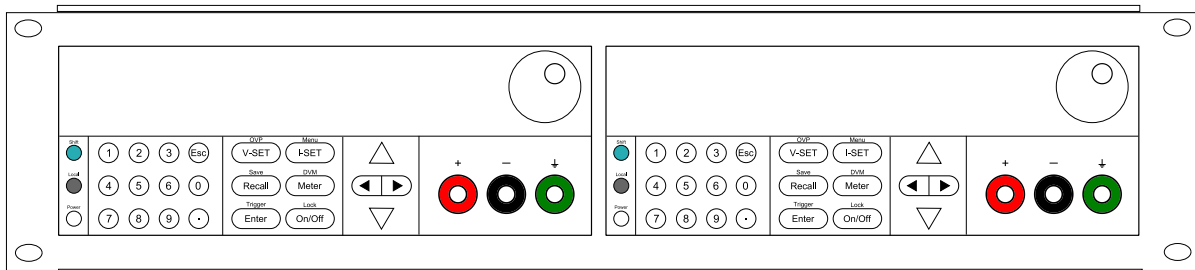

To rackmount two instruments side-by-side, order rackmount kit IT-E151, the front cover panel is not needed.

1.5 Front Panel Overview

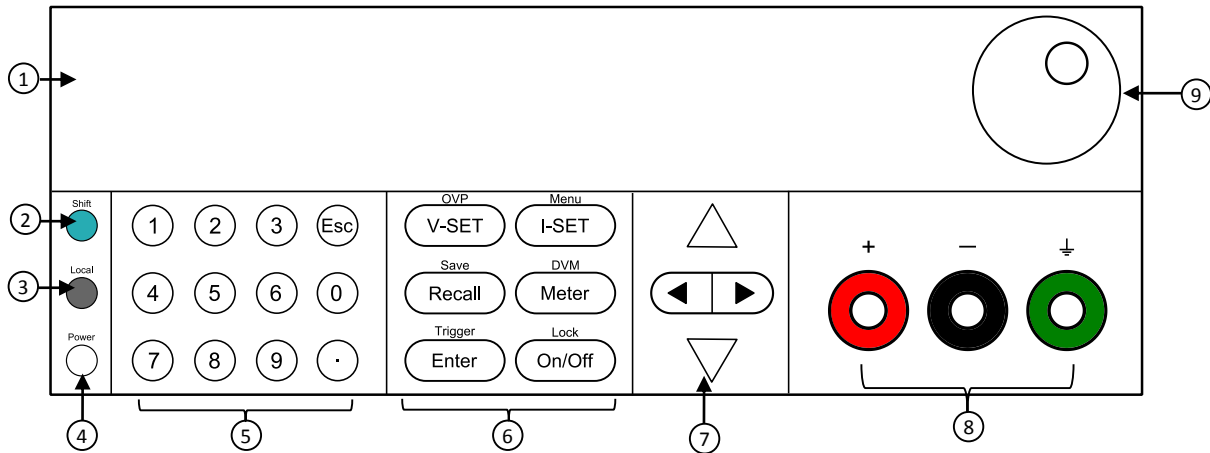

Figure 1 Front Panel View

Front Panel Description

① VFD display

② Shift key

③ Local key

④ Power key

⑤ Numeric keys

⑥ Function keys

⑦ Cursor keys

⑧ Output terminal

⑨ Rotary knob

1.6 Keypad Overview

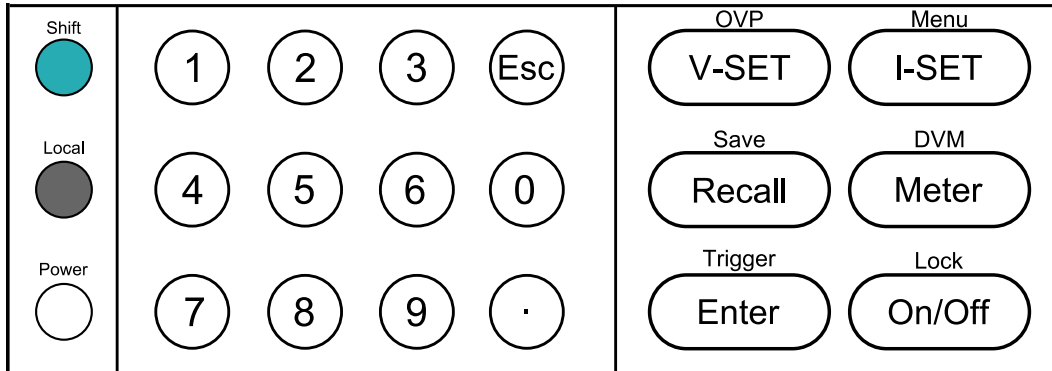

Figure 2 Keypad View

Keypad Description

	Shift key <i>Enables access to secondary functions (Labeled in blue)</i>
	Local key <i>Sets the instrument back to local mode.</i>
	Power key <i>Power on the instrument.</i>
	Numeric keypad <i>Enters numeric values for various parameters.</i>
	Vset / OVP button <i>Configures output voltage or sets the overvoltage protection point for the power supply.</i>
	Iset / Menu button <i>Configures output current or allows access to the power supply menu settings.</i>
	Recall / Save button <i>Saves and recalls instrument settings.</i>
	Meter / DVM button <i>Switches from set value display to metered output value display or switches to digital voltmeter function.</i>
	Enter / Trigger key <i>Confirms setting/parameter changes or used to trigger a list program.</i>
	Output / Lock button <i>Controls output On/Off state of the power supply or used to lock the front panel buttons.</i>
	Left/Right arrow keys <i>Adjusts cursor position or select menu items.</i>



Up/Down arrow keys

Used to select menu items or increase/decrease output voltage or output current values.

**Esc key**

Cancel and return to previous menu.

1.7 Rear Panel Overview

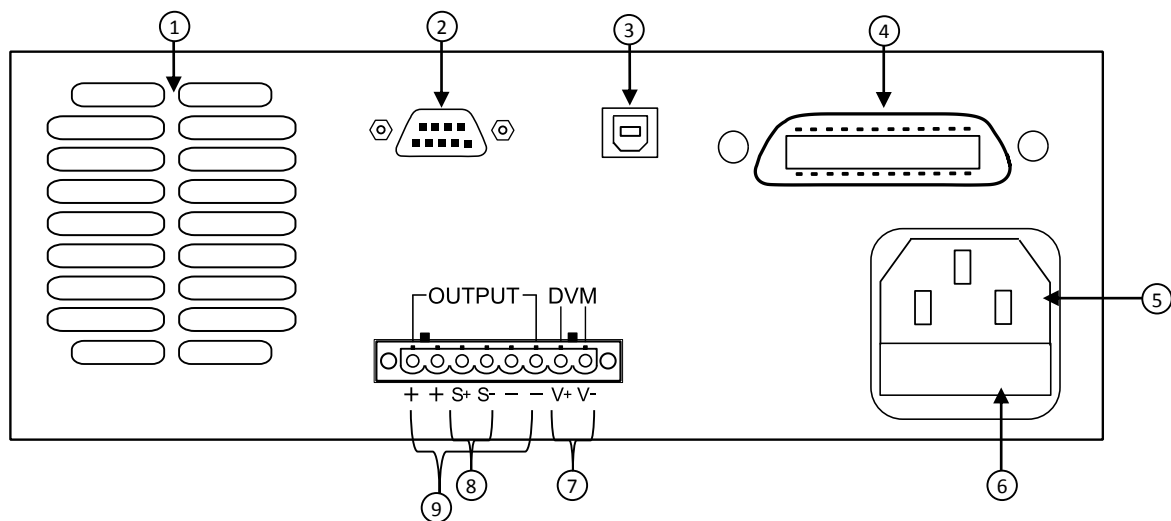

Rear Panel Description

-
- ① Cooling fan

 - ② RS-232 interface

 - ③ USB interface

 - ④ GPIB interface

 - ⑤ AC power input receptacle

 - ⑥ Fuse box

 - ⑦ DVM input terminal

 - ⑧ Remote sense terminal

 - ⑨ Output terminal
-

1.8 Display Overview



Display Description

OFF	Indicates output is off
CV	The power supply is in constant voltage mode
CC	The power supply is in constant current mode
*	Not used
Timer	Indicates output on timer function is ON
Sense	Indicates remote sense
Ext	Not used
Adrs	Indicates remote communication activity
Meter	Indicates Meter ON state
Shift	Indicates shift mode (for access to secondary button functions)
OVP	Indicates overvoltage protection trip
OCP	Indicates overcurrent protection trip
Rmt	Indicates remote mode
Error	Indicates an error has occurred
Prot	Indicates protection trip for overvoltage or overtemperature
Lock	Indicates key lock is enabled

2 Getting Started

Before connecting and powering up the instrument, please review and go through the instructions in this chapter.

2.1 Input Power and Fuse Requirements

Input Power

The supply has a selectable AC input that accepts line voltage input within:

Voltage: **110 V (+/- 10 %) or 220 V (+/- 10 %)**

Frequency: **47 Hz – 63 Hz**

Before connecting to an AC outlet or external power source, be sure that the power switch is in the OFF position and verify that the AC power cord, including the extension line, is compatible with the rated voltage/current and that there is sufficient circuit capacity for the power supply. Once verified, connect the cable firmly.

⚠ WARNING



The included AC power cord is safety certified for this instrument operating in rated range. To change a cable or add an extension cable, be sure that it can meet the required power ratings for this instrument. Any misuse with wrong or unsafe cables will void the warranty.



SHOCK HAZARD:

The power cord provides a chassis ground through a third conductor. Verify that your power outlet is of the three-conductor type with the correct pin connected to earth ground.

Fuse Requirements

An AC input fuse is necessary when powering the instrument. Below is a table of the fuse required for all models operating with either 110 VAC or 220 VAC input.

Table 1 - Fuse Requirements

Model	Fuse Specification (110 VAC)	Fuse Specification (220 VAC)
9201	T6.3A 250V	T3.15A 250V
9202	T10A 250V	T6.3A 250V
9205	T15A 250V	T10A 250V
9206	T15A 250V	T10A 250V

2.2 Line Voltage Selection

The power supplies can be selected to operate with 110 V input or 220 V input. To ensure that your instrument is properly configured to operate at the desired AC line voltage, please follow the steps below:

⚠ WARNING

For safety, no power should be applied to the instrument while changing line voltage operation. Disconnect all cables connected to the instrument before proceeding.

Step 1 - Check and/or Change Fuse

- Locate the fuse box next to the AC input connector in the rear panel.
- With a small flat blade screwdriver, insert into the fuse box slit to pull and slide out the fuse box as indicated below.
- Check and replace fuse (if necessary) for the desired line voltage operation (see Table 1).

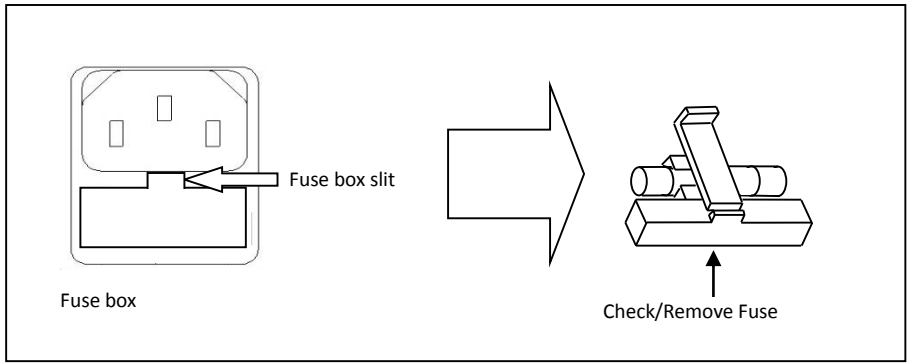

Figure 3 - Fuse replacement

Step 2 - Check and/or Change Line Voltage Switch

- Locate the Line Voltage Switch, which has markings that indicate “110” for 110V or “220” for 220V line operation. Depending on the model, the Line Voltage Switch will be located either on the rear or bottom of the instrument. Set the switch to the desired line voltage operation.

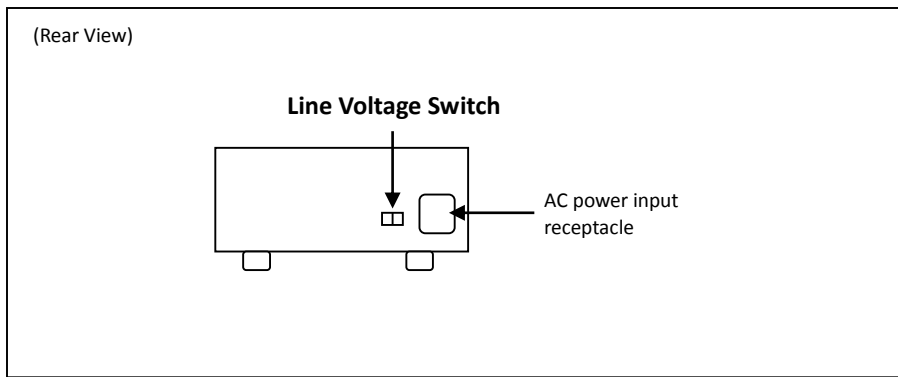

Figure 4 - Models 9201/9202 Line Voltage Switch Location

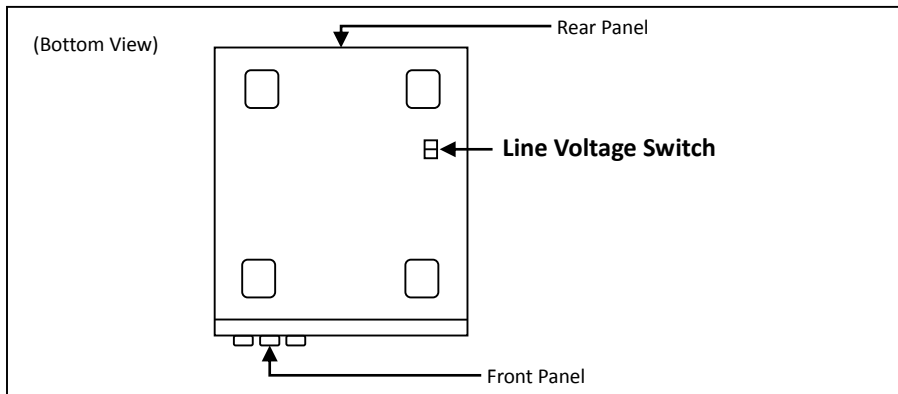

Figure 5 - Models 9205/9206 Line Voltage Switch Location

⚠ WARNING

Do not connect power to the instrument until the line voltage selection is setup correctly. Applying an incorrect line voltage or configuring the line voltage selection improperly may damage the instrument and void all warranty.

⚠ WARNING

Any disassembling of the case or changing the fuse not performed by an authorized service technician will void the warranty of the instrument.

2.3 Output Connections

The main DC output terminal is a binding post terminal on the front panel.

Due to the high current rating of the power supply, proper wire sizes are necessary for safe connectivity and to prevent wires from overheating. Refer to the table below as a reference for proper wire sizes according to the amount of current used for operation:

Table 2 - Wire Gauge Rating

AWG	6	8	10	12	14	16	18	20	22
I _{max} (A)	75	55	40	25	20	13	10	7	5
mΩ/meter	1.3	2.1	3.3	5.2	8.3	13.2	21	33.5	52.8

⚠ WARNING

Before connecting wires to the output terminals, turn OFF the power supply to avoid damage to the instrument and the device under test (DUT). For safety, load wires must have a wire gauge size large enough to prevent overheating when the power supply operates at maximum short circuit output current. It will also prevent large voltage drops from resistances in the wires.

SHOCK HAZARD:

Hazardous voltages may exist at the outputs and the load connections when using a power supply with a

rated output greater than 40V. To protect personnel against accidental contact with hazardous voltages, ensure that the load and its connections have no accessible live parts. Ensure that the load wiring insulation rating is greater than to the maximum output voltage of the power supply.

2.4 Preliminary Check

Complete the following steps to verify that the power supply is ready for use.

1. Verify AC Input Voltage

Verify and check to make sure proper AC voltages are available to power the instrument. The AC voltage range must meet the acceptable specification as explained in “2.1 Input Power and Fuse Requirements”.

2. Connect Power and Self-Test

Connect AC power cord to the AC receptacle in the rear panel and press the power switch to the I(ON) position to turn ON the instrument. It will run through a self-test procedure.

Self-test Errors

The following errors will be displayed if self-test did not complete successfully:

Error Message on Display	Description
EEPROM FAIL	The internal EEPROM is corrupted or damaged.
SYST LOST	Last system settings within the EEPROM is lost.
CAL LOST	Calibration data within the EEPROM is lost.
FACT LOST	Factory calibration data is lost.

If any of these errors occur, please contact B&K Precision.

Output Check

Voltage Check

Follow the steps below to check basic voltage output with no load connected.

1. Turn on the power supply. The display will show the **OFF** annunciator above the voltage display.

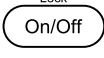
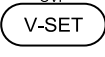
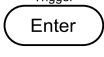
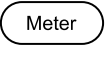
2. Enable the output by pressing , and the button will be lit. The **OFF** annunciator will change to **CV**.
3. Using the numeric keypad or the voltage adjust knob and enter a voltage value. The voltage display will now show the value you entered. If entering with numeric keypad, press  first, then enter the value and press .
4. If the  button is not already lit, press it once and the voltage display will show the measured voltage at the output, which may fluctuate slightly from the voltage value entered in the previous step.
5. (Optional) You may also verify the output voltage by connecting the (+) and (-) terminals to an external voltmeter. The measured value should match or be comparable to the entered voltage value.

Current Check



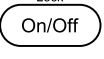
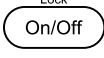
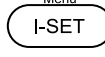
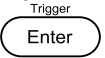
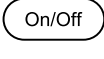



Follow the steps below to check basic current output of the power supply.

1. Turn on the power supply. The display will show the **OFF** annunciator above the voltage display. Be sure that the output is disabled (the  should not be lit when it is off).
If not, press  to disable output.
2. Short the (+) and (-) output terminals with test leads, shorting bar, or clip. (Refer to “Table 2 - Wire Gauge Rating” to select appropriate test leads)
3. Using the numeric keypad or the current adjust knob, enter a small current value (i.e. 1.000 A). If entering with numeric keypad, press  first, then enter the value and press . The current display will now show the value you entered.
4. Enable the output by pressing , and the button will be lit. The **OFF** annunciator will change to **CC**.
5. If the button is not already lit, press it once and the current display will show the measured current at the output, which may fluctuate slightly from the current value entered in step 3.
6. (Optional) You may also verify the output current by connecting the (+) and (-) terminals to an external current meter capable of measuring the current that you set. The measured value should match or be comparable to the entered current value.
7. Press the power switch to turn off the power supply and remove the short on the output terminals.

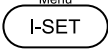
Check Model and Firmware Version

The model and firmware version can be verified by using the ***IDN?** query remote command. It

can also be found from within the menu system by following these steps:

1. Press  and  to enter the menu system.
2. Use the   keys to select Power Info and press .
3. Press   keys to cycle through power supply information.
4. Press  twice to exit the menu and return to the normal display.

3 Front Panel Operation







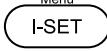

3.1 Menu Options

All settings and parameters can be configured from the built-in menu system of the power supply. The menu system is divided into the following sections and organized as follows:

MAX VOLT	Set the maximum voltage limit of the power supply.
OCP SET	Set the overcurrent protection limit.
SYST SET	
P-MEM	Set the power-on state.
P-OUT	Enable/disable power-on output state.
COMM	Select and configure communication interface.
BEEP	Enable/disable key sound.
KNOB	Lock/unlock the rotary knob function.
TRIG	Select manual or external trigger.
MEM	Select memory group location for save/recall instrument settings.
TIMER SET	Enable/disable timer function.
RESET	Restore factory settings.
LIST SET	
LIST STATE	Enable/disable List test function.
LIST LOAD	Recall saved list file.
LIST EDIT	Edit a list file.
POWER INFO	Shows model, firmware version, communications settings, and other power supply information.

How to Access the Menu

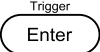
Before using the instrument, it is important to be familiarized with its menu structure and learn how to view or change settings and parameters. Follow the steps below to guide you in selecting menu options.







1. From the normal display, press  and  to enter the menu.
2. The selected item will be blinking. Use the   keys to move through the menu selections.
3. When the desired menu section is shown, press  to access its menu settings.
4. The selected item will be shown. Use the   keys to move through the menu items.
5. Press  to access the selected menu item.
6. There may be parameters or options to select within each menu item. Follow the same instructions as described in the previous steps to select them. To save changes to a setting, press .
7. To exit the menu at any time, press  twice.

3.2 Configure Voltage and Current Output

Voltage and current can be set from the front panel. Remote sense is also available on the rear panel for voltage compensation at the output.

Setting Voltage

Follow the steps below to set the output voltage:

1. From the normal front panel display, users can use either the voltage adjust knob, numeric keypad, or the   keys to enter the setting voltage.
2. If entering using numeric keypad, press  first so that the cursor selects the voltage display. Then, enter the value and press  to set the voltage.
3. To change the cursor position to adjust with the voltage adjust knob, use the   keys to move left or right.

Note: To see the changes to the setting voltage, be sure the display is not showing the measured voltage. This can be checked by looking for the LED indicator of the



button. If it is not lit, the display is showing the setting voltage.

When output is ON, the user can use the rotary to adjust the voltage value when the output is in constant voltage (CV) mode. The output value will change simultaneously with the adjusted value. This allows the user to quickly change the output value if the test is needed.

Setting Current

Follow the steps below to set the output current:

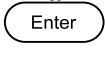
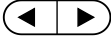
1. From the normal front panel display, users can use either the current adjust knob, numeric keypad, or the \triangle ∇ keys to enter the setting current.
2. If entering using numeric keypad, press  first so that the cursor selects the current display. Then, enter the value and press  to set the current.
3. To change the cursor position to adjust with the voltage adjust knob, use the  keys to move left or right.

Note: To see the changes to the setting current, be sure the display is not showing the measured current. This can be checked by looking for the LED indicator of the

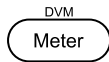

button. If it is not lit, the display is showing setting current.

When output is ON, the user can use the rotary to adjust the current value when the output is in constant current (CC) mode. The output value will change simultaneously with the adjusted value. This allows the user to quickly change the output value if the test is needed.

Remote Sense

Remote sense can be used to compensate for voltage drops (up to 1 V) due to resistance from test leads connected to your device under test (DUT), thus providing more accurate output voltage. The power supply is initially set up to local sense mode by default. Refer to the following sections for details of local and remote sense setup.

Local Sense

By default, the power supply is set up for local sense. This is determined by the wire connections in the rear panel, illustrated below:

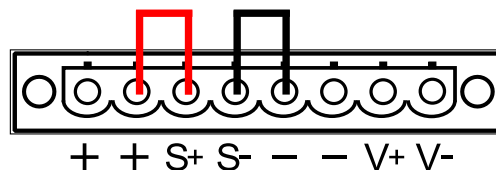

Figure 6 – Local Sense Setup

When local sense is selected, the positive sense (S+) is connected to the positive lead (+) and negative sense (S-) is connected to the negative lead (-), whereas the positive lead (+) of the DC

output is connected to the positive end (+) of the load and the negative lead (-) of the DC output is connected to the negative end (-) of the load. When this sensing mode is selected, the wires connecting between DC outputs to the load must be as short as possible. The local sense is the default configuration with shorting bars connected between (S+) to (+) and (S-) to (-).

⚠ WARNING

DO NOT disconnect the wires if remote sense is not used. Doing so will cause erratic behavior and may damage the power supply under certain conditions.



Never connect any power source into any of the four terminals at any time during operation.

When output is enabled, DO NOT use your hands to touch the terminals or the screws that are designed to tighten wires to the terminals. Doing so may create a shock hazard under high voltage output conditions.

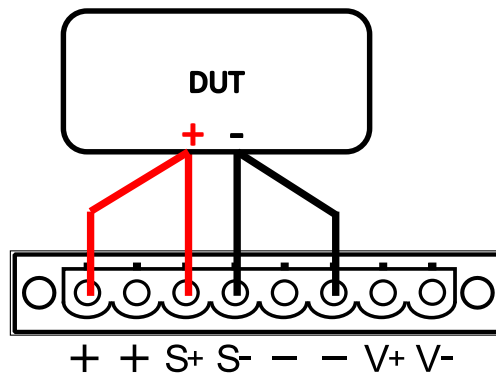

Figure 7 - Remote Sense Connection

Remote Sense

When remote sense is selected, the positive sense (+S) and positive lead (+) of the DC output are connected to the positive end (+) of the load, whereas the negative sense (-S) and negative lead (-) of the DC output are connected to the negative end (-) of the load.

To enable remote sense, follow the steps below:

1. Power OFF the supply and disconnect all loads and cables connected to it.
2. Use a small flat blade screwdriver to loosen the wire connection connected between **+** and **S+** and **S-** and **-**.
3. Connect the **S+** to the DUT's positive (+) terminal, and connect the **S-** to the DUT's negative (-) terminal.
4. Do not connect any wires to + and - terminals.

5. Power ON the power supply, and then configure and enable the output. The setup should look like the figure above.

⚠ CAUTION



DO NOT at any time disconnect the wires from the S+ and S- terminals to the DUT while output is enabled (ON). Doing so may damage the power supply and cause unstable output.

3.3 Voltage/Current Measurement

The display will show the set voltage and current values or the measured values of the output.

To toggle this reading, press  key. When the Meter LED indicator is on, the display shows the measured voltage and current values. When the Meter LED indicator is off, the display shows the set voltage and current values.

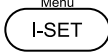
3.4 SYSTEM Menu

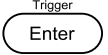



All setup procedures and settings explained in this section can be accessed from the **SYST SET** menu. To access this menu, press  and . Use the   keys to select **SYST SET** and then press .

Voltage Limit Setting

The voltage output limit can be configured to provide limit protection to prevent accidental changes to the output settings.

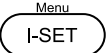

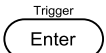
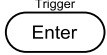

Note: If you are unable to set to a desired voltage, check these limit settings to make sure the set value is within the limit's range.

Follow the steps below to configure the maximum voltage limit.

1. Press  and  to enter the power supply menu.
2. Use the   keys to select **MAX VOLT** and then press .
3. Use the numeric keypad to enter the maximum voltage limit and press  to confirm.
4. To exit the menu at any time, press  twice.

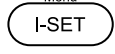
Configure Overcurrent Protection (OCP)

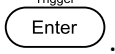
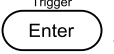
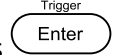

The 9200 Series power supply provides an overcurrent protection (OCP) function to protect the power supply when the current presented at the output terminal exceeds the OCP current setting. Follow the steps below to set the OCP limit.

1. Press  and  to enter the power supply menu.
2. Use the   keys to select **OCP SET** and then press .
3. Select **ON** and press  to confirm. (To disable the OCP function, select **OFF**.)
4. Use the numeric keypad to enter the OCP limit value and press  to confirm. When enabled, the **OCP** indicator will be shown on the display.
5. To exit the menu at any time, press  twice.

When OCP protection is tripped during operation, the output will turn off and the power supply will display **OVER CURR** with **Prot** indicator lit up. To clear the trip status, press any key once.

Configure Power-On State

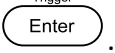
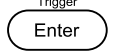
The initial Power-On state of the power supply can be configured (voltage, current) by following the steps below:

1. From the **SYSTEM** menu, select **P-MEM** and press .
2. There are two options that can be selected using the rotary knob:
LAST – Last voltage, current, and output state values before power OFF.
DEF – Default voltage, current, and output state values.
3. Select desired settings for power up, and press  to save changes. If **LAST** has been selected, set user-defined voltage and current state before power OFF.
4. To exit the menu at any time, press  twice.





Remote Communication Configuration

To set up remote interface connections and settings, refer to chapter 4 “Remote Operation”.

Enable/Disable Key Sound





The instrument initially has key sound enabled from factory. To disable or re-enable the key

sound, follow the steps below:

1. From the **SYST SET** menu, select **BEEP** and press . Select between the two options using the rotary knob or   keys:
ON – Enable key sound
OFF – Disable key sound
2. Select the desired option and press  to save the change.
3. To exit the menu at any time, press  twice.





Lock/Unlock Rotary Knob

The instrument initially has the rotary knob enabled from factory. To lock or re-enable the rotary knob, follow the steps below:

1. From the **SYST SET** menu, select **KNOB** and press . Select between the two options using the   keys:
ON – Enable rotary knob
LOCK – Lock rotary knob
2. Select the desired option and press  to save the change.
3. To exit the menu at any time, press  twice.

Configure Trigger Source

The trigger function is used to initiate the start of running a program sequence (list). The trigger source can be set so that users can send a trigger from the front panel or through a remote command via remote interface. Follow the steps below to configure the trigger mode:





1. From the **SYST SET** menu, browse and select **TRIG** and press .
2. There are two options:
MANU (Default) – Manual trigger. Front panel trigger button is used to send a trigger (press  and  to send trigger).
BUS – Bus trigger. Remote command ***TRG** is used to send a trigger.
3. To exit the menu at any time, press  twice.

Save/Recall Instrument Settings

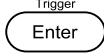

The instrument can save up to 72 sets of voltage/current values for quick recall access. Memory is allocated in 8 different storage groups (group 1 to 8) and each group has 9 memory locations

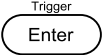
to store settings (1 to 9). The memory group must first be selected from the menu before settings can be saved within the group.

Select Storage Group

1. From the **SYST SET** menu, browse and select **MEM** and press .
2. Use   keys or rotary knob to enter the storage group. Select between **GRP1 – GRP8** and press  to save selection.
3. To exit the menu at any time, press  twice.

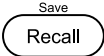
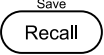
Save Settings

1. Set up output voltage and current settings that you want to save and press  and  to enter **Save** mode.
2. If entered properly, you will see the  button flash on and off until a Save location value is entered.
3. Use the numeric keypad to enter the memory location between **1 – 9** in which to store current instrument settings.
4. To exit **Save** mode at any time, press .

Recall Settings

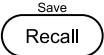
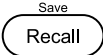
1. Press  to enter **Recall** mode. If entered properly, the  button will be lit.
2. Use the numeric keypad to enter the memory location between **1 – 9** to recall. The voltage and current settings of that memory location will immediately be recalled and displayed. If the selected memory location does not have any saved settings, the message “DATA EMPTY” will be displayed.







Note: When in Recall mode, users can recall settings from different locations without having to press additional keys each time. For example, you can press 1 to recall settings in location 1, and then press 5 to immediately recall settings in location 5.

3. To exit **Recall** mode, press .

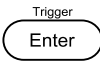
Timer Function

The timer function allows the user to set up how long the output will be enabled when it is initially turned ON. When enabled, the **Timer** indicator will be shown on the display.

To activate the timer function, follow the steps below.

1. From the **SYST SET** menu, browse and select **TIMER SET** and press .
2. Select between the two options using the rotary knob or   keys:
OFF – Disable timer function
ON – Enable timer function
3. Select **ON** and press  to save the change.
4. Use the numeric keypad, cursor keys, or rotary knob to configure the output time between 0.1 – 99999.9 seconds.
5. Press  to complete the timer setting.
6. Press  twice to exit the menu.
7. Press the  key to enable the output and start the timer. The output will automatically turn OFF after the timer countdown is complete.

Restore Factory Default Settings

All instrument settings can be reset back to their factory default values by doing the following:

Note: Restoring the instrument to factory default will change all current instrument settings and parameters back to their default values.









1. From the **SYST SET** menu, select **RESET** and press .
2. Select between the two options using the rotary knob or   keys:
NO – To cancel reset
YES – To confirm reset
3. The instrument will return to the normal display and all settings are now restored back to factory default. The table below lists some of the factory default settings.

Table 2 - Factory Default Settings

Item	Parameter	9201	9202	9205	9206
Output	Voltage	0.0 V	0.0 V	0.0 V	0.0 V
	Current	10.1 A	15.1 A	25.1 A	10.1 A

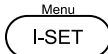
Protection	OVP, OVP Voltage	OFF, 66 V	OFF, 66 V	OFF, 66 V	OFF, 156 V
	OCP, OCP Current	OFF, 11.1 A	OFF, 16.1 A	OFF, 26.1 A	OFF, 11.1 A
Beep	Mode	ON	ON	ON	ON
Max Volt	Limit	61 V	61 V	61 V	151 V
Comm	Interface	RS-232	RS-232	RS-232	RS-232

3.5 LIST Menu

All setup procedures and settings explained in this section can be accessed from the **LIST SET** menu. To access this menu, press  and . Use the   keys to select **LIST SET** and then press .

This menu configures the List mode function of the power supply. List mode allows you to create a sequence of steps, store it into the power supply's non-volatile memory, and execute it. The input parameters for generating a list include voltage, current, and time value of each step. Up to 10 list files can be stored, each allowing a maximum of 150 steps.

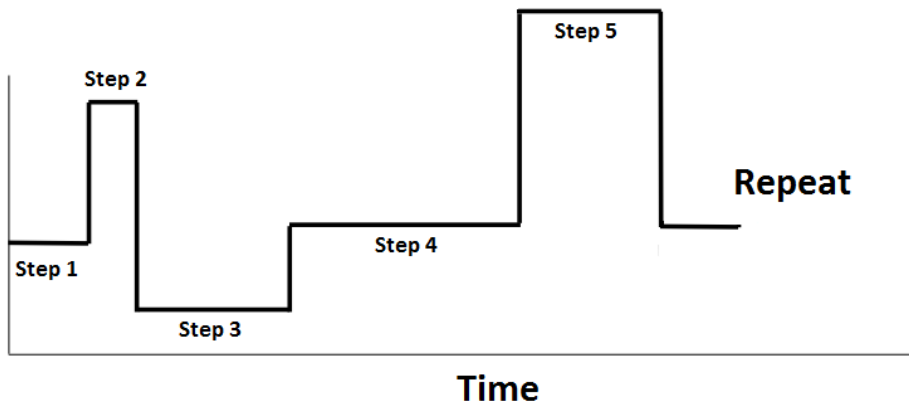





Enable/Disable List Mode

The initial LIST mode state of the power supply can be configured by following the steps below:





1. From the **LIST SET** menu, select **LIST STATE** and press .
2. There are two options that can be selected using the rotary knob:
OFF – Disable **List** mode

ON – Enable List mode

3. Select the desired option and press  to save the change.
4. To exit the menu at any time, press  twice.
5. When List mode is enabled, the  will be lit until triggered.
6. To run a loaded list file, set the Trigger mode (Refer to “Configure Trigger Source” section) and manually or remotely trigger the power supply. The  button will blink while running a list file.

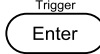



Note: Voltage and current settings cannot be changed while List mode is enabled.



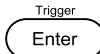
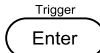

Load List File

1. From the **LIST SET** menu, select **LIST LOAD** and press .
2. Use   keys or rotary knob to select one of the stored list files between **FILE0 – FILE9** and press .
3. To exit the menu at any time, press  twice.

Edit List File







To edit a list, follow the procedure below.

1. From the **LIST SET** menu, select **LIST EDIT** and press .
2. Use   keys or rotary knob to select unit of time (**Sec** or **Min**) for steps.
3. **VSET** will be displayed. Use the numeric keypad to enter the step’s voltage value and press  to confirm.
4. **ISET** will be displayed. Use the numeric keypad to enter the step’s current value and press  to confirm.
5. As specified previously, **SEC** or **MIN** will be displayed. Use the numeric keypad to enter the step’s time value and press  to confirm.
6. **NEXT** will be displayed. To enter another step, select **YES** and press  to confirm.
7. Repeat steps 3-6 for remaining steps. When finished, select **NO** for **NEXT** to specify there are no more steps to be added.

8. **CYCLE** will be displayed. Use the numeric keypad to enter the number of cycles to run the list and press  to confirm.
9. **SAVE** will be displayed. To save the list file to a memory location, use the   keys or rotary knob to select save location (**FILE0 – FILE9**). Select **NO** to run the list without saving.
10. To exit the menu at any time, press  twice.

3.6 Overvoltage Protection (OVP)

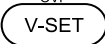
The 9200 Series power supply provides an overvoltage protection (OVP) function to protect the power supply when the voltage presented at the output terminal exceeds the OVP voltage setting. Follow the steps below to set the OVP limit.



1. Press  and  to set and enable the OVP function.
2. Use the numeric keypad to enter the OVP limit value and press  to confirm. When enabled, the **OVP** indicator will be shown on the display.
3. To disable OVP, press  and  again and the **OVP** indicator will not be shown on the display.
4. To exit the menu at any time, press .

When OVP protection is tripped during operation, the output will turn off and the power supply will display **OVER VOLT** with **Prot** indicator lit up. To clear the trip status, press any key once.

Note: Avoid exceeding 120% of the rated voltage across the output terminals or it will damage the power supply.

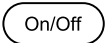

3.7 Key Lock

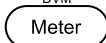
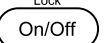
The front panel keys can be locked to prevent unwanted changes to output settings and power supply configurations. Follow the steps below to enable/disable key lock.

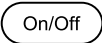
1. Press  and . A **Lock** indicator will light up on the display, indicating that the front panel keys are locked. At this point, all keys are disabled except for , , and .

2. To unlock the keys, press  and  again. The **Lock** indicator will disappear and all keys will be enabled.

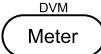
3.8 Digital Voltmeter (DVM)

The power supply provides a built-in digital voltmeter which can measure DC volts in a range from 0.001 V - 60.000 V. The connectors are on the rear panel. Press  and  to enable the DVM. To exit out of the DVM function, press  or any other function key.

To measure voltages, connect the leads as shown here:

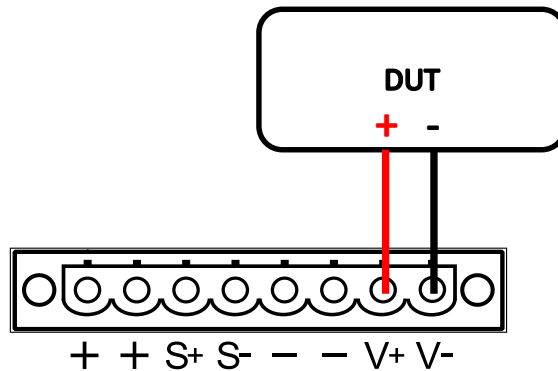



Figure 8 - DVM connection

4 Remote Operation

There are several interfaces available for remote communication: USB, RS-232, and GPIB. With all these interfaces, this power supply is very flexible to be controlled remotely. Users can program the power supply by using the SCPI (Standard Commands for Programmable Instruments) commands over any one of the remote interfaces. This section will describe how to set up all of the supported interfaces.

Note: The **RMT** indicator will appear on display when the power supply is successfully connected to a PC remotely through any remote interface. Keys on the front panel will be locked until the instrument is in LOCAL mode. To return to LOCAL mode from the front panel, press . The **RMT** indicator will disappear when the instrument is in LOCAL mode.

4.1 Interface Configuration

RS-232

For RS-232 connectivity, refer to the diagram below for pinout information. The RS-232 is labeled in the rear panel and it is a female DB-9 interface.

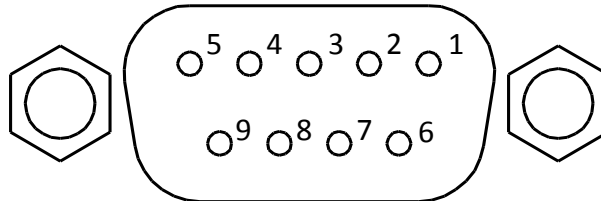
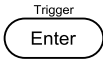

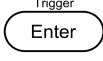

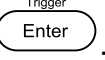

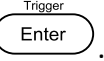

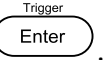
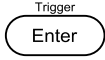

Table 3 - RS232 Pin Outs

PIN	Description
1	-
2	Transmit Data
3	Receive Data
4	-
5	GND
6	-
7	CTS
8	RTS
9	-

A straight pin-to-pin DB9 female to DB9 male serial cable is required for using the RS-232 interface. Do not use a null modem or crossover DB9 serial cable.

Follow the steps below to configure the power supply for RS-232 operation:

1. From the **SYST SET** menu, select **COMM** and press .
2. Press  keys or rotary knob until **RS-232** is displayed and press  to configure the settings for RS-232 remote communication.
3. Use  keys or rotary knob to select the baud rate setting and press .
4. Use  keys or rotary knob to select the parity setting and press .
5. Use  keys or rotary knob to select the mode setting and press .
6. If MUX mode has been selected, then specify the ADDR of the supply.
7. Press  to save each setting and the display will return to the **RS232** menu.
8. Below lists the options that can be changed for each setting:
Baud rate: 9600 (default), 19200, 38400, 57600, 115200
Parity/data bits: None/8 bits (default), Even/8 bits, Odd/8 bits





Note: The RS-232 interface does not have flow control mechanism. The programmer should be aware of this limitation and notice the command process time of the power supply. If the remote commands are sent too fast to the power supply, the internal buffer may overrun and cause a communication error. Therefore, a delay between commands to let the power supply have enough time to process them is mandatory.

9. All serial settings must match the settings configured on the PC in order for communication to link successfully.

USB

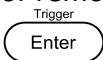
The standard USB port is a USBTMC-compliant port that can be used for remote communication. There are no additional settings in the menu system for USB configuration. The only requirement is that NI-VISA is installed on the computer, which can be downloaded at <http://www.ni.com/visa/>.

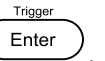
Follow the instructions below to select the USB interface for remote operation.



1. From the **SYST SET** menu, select **COMM** and press .
2. Press  keys or rotary knob until **USB** is displayed and press .
3. To exit the menu at any time, press  key twice.

GPIB

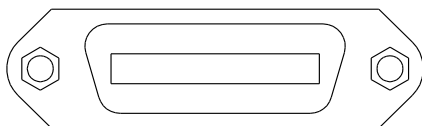
Each model can be configured with a GPIB address from 1-30. To communicate via GPIB, connect a GPIB cable to the GPIB interface on the rear panel, as illustrated below.

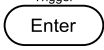

Follow the instructions below to select and configure the GPIB interface for remote operation.

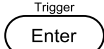
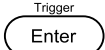
1. From the **SYST SET** menu, select **COMM** and press .
2. Press   keys or rotary knob until **GPIB** is displayed and press  to configure the settings for GPIB remote communication.
3. Configure the GPIB **Address** to which the power supply will be assigned to. Use the rotary knob or numeric keypad to enter a value from 1-30 and press .
4. Make sure the address assigned to the power supply unit matches the address the data commands are being sent to.

5 Remote Commands

5.1 Parameter Definition

The 9200 Series power supplies support communication protocols, which include standard SCPI commands and a few proprietary commands that follow the SCPI convention. The SCPI interface enables users to operate the power supply through a computer or a terminal equipped with IEEE-488.2 GPIB, RS-232, or USB interface. SCPI IEEE-488.2 also supports multi-unit control allowing a user to control up to 32 power supplies.

The following table lists all of the numerical parameters.

Symbol	Response Formats
<bool>	Boolean value, can be 1 or "ON", 0 or "OFF"
<NR1>	Integer value, can be zero, positive or negative integer number
<NRf>	Flexible numerical value, can be zero, positive or negative float point numeric value
<string>	String value, characters enclosed in single or double
<NL>	New line, hex code 0x0Ah
<Rtn>	Return, hex code 0x0Dh

All commands should be ended with the <Rtn> and <NL> and there should be a space between command and numerical parameter.

5.2 SCPI Status Register

The 9200 Series power supply records the different states of the instrument through four status registers. The four status register groups are status byte register, standard event register, query status register, and operation status register. The status byte register records the information of the other registers. The following tables provide the details on each register's meaning.

Questionable Status

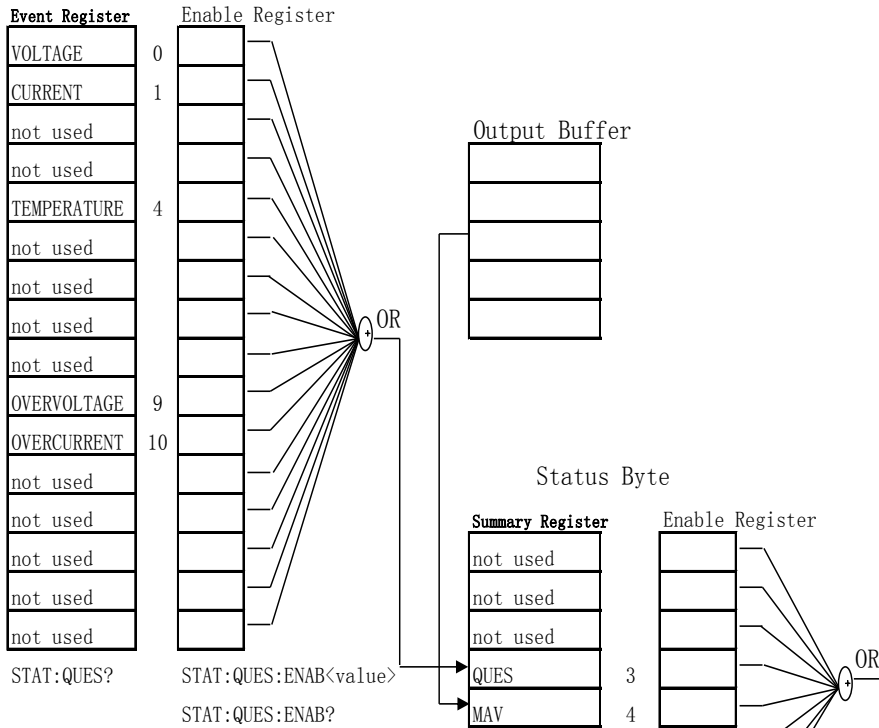

Standard Event

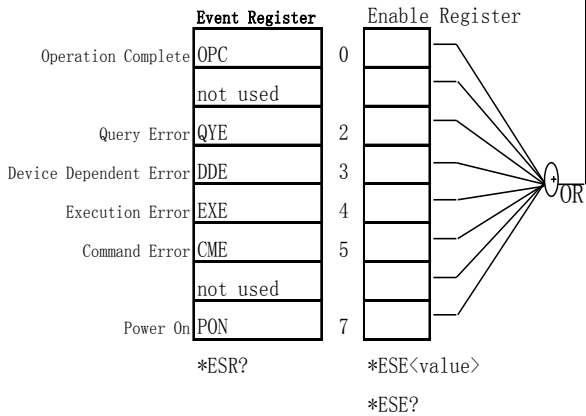

Operate Event

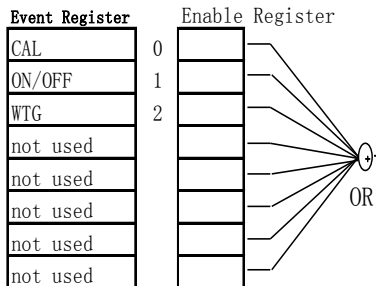

Standard event status register

Bit		Decimal Value	Definition
0	OPC	1	Operation Complete. All commands prior to and including an *OPC command have been executed.
1	Not used	0	Always set to 0.
2	QYE	4	Query Error. The power supply tried to read the output buffer but it was empty. Or, new command line was received before a previous query had been read. Or, both the input and output buffers are full.
3	DDE	8	Device Error. A self-test or calibration error occurred (see error numbers 601 through 750 in chapter 5).
4	EXE	16	Execution Error. An execution error occurred (see error numbers -211 through -224 in chapter 5).
5	CME	32	Command Error. A command syntax error occurred (see error numbers -101 through -178 in chapter 5).
6	Not used	0	Always set to 0.
7	PON	128	Power On. Power has been turned off and on since the last time the event register was read or cleared

Query status register

Bit		Decimal Value	Definition
0	Voltage	1	The power supply is/was in the constant current mode.
1	Current	2	The power supply is/was in the constant voltage mode.
2-3	Not used	0	Always set to 0.
4	Overtemperature	16	The fan has a fault condition.
5-8	Not used	0	Always set to 0.
9	Overvoltage	512	The overvoltage protection circuit has tripped.
10	Overcurrent	1024	The overcurrent protection circuit has tripped.
11-15	Not used	0	Always set to 0.

Status byte register

Bit		Decimal Value	Definition
0-2	Not used	0	Always set to 0.
3	QUES	8	One or more bits are set in the questionable status register (bits must be "enabled" in the enable register).

4	MAV	16	Data is available in the power supply output buffer.
5	ESB	32	One or more bits are set in the standard event register (bits must be “enabled” in the enable register).
6	RQS	64	The power supply is requesting service (serial poll).
7	Not used	0	Always set to 0.

5.3 IEEE488.2 Common Commands

Here’s a list and description of all common SCPI commands supported by the instrument.

*CLS

This command clears the following registers:

- Standard event register
- Query event register
- Operation event register
- Status byte register
- Error code

Command syntax: *CLS

Parameter: None

*ESE

This command can set the parameter of standard event enable register. Setting parameter can determine which bit of standard event register is 1 and the byte will enable ESB of status byte register as 1.

Command syntax: *ESE <NR1>

Parameter: 0~255

The value when power on: Refer to *PSC command

Example: *ESE 128

Query syntax: *ESE?

Returned parameter: <NR1>

The bit definition of the standard event enabled register:

Bit Position	7	6	5	4	3	2	1	0
Bit Name	PON	Not used	CME	EXE	DDE	QYE	Not used	OPC
Bit Weight	128		32	16	8	4		1

PON Power-on

CME Command error

EXE Execution error

DDE Device-dependent error
QYE Query error
OPC Operation complete

***ESR?**

This command can read the value of standard event status register. After executing this command, standard event status register is reset. Bit definition of standard event status register is the same as the standard event status enable register.

Query syntax: *ESR?

Parameter: None

Returned parameter: <NR1>

***IDN?**

This command can read information about power supply. The returns parameter contains 4 segments divided by comma.

Query syntax: *IDN?

Parameter: None

Returned parameter: <AARD> segment description

Manufacturer, Model, Serial number, Software version

Example: B&K Precision, 9205, 602203010697410001, V1.09-V1.04

***OPC**

When all commands before this command are executed, bit OPC in standard event register will be set to 1.

Command syntax: *OPC

Parameter: None

Query syntax: *OPC?

Returned parameter: <NR1>

***PSC**

This command controls whether the power supply sends a query or not when it is reset. If set to 1 or ON, the operation event enable register, quest event enable register, and standard event status register will be reset when power supply is reset. When set to 0 or OFF, the data of the status byte register, operation event enable register, quest event enable register and standard event status enable register will be stored in non-volatile memory and recalled when power supply is reset.

Command syntax: *PSC <bool>

Parameter: 0|1|ON|OFF

Query syntax: *PSC?

Returned parameter: <NR1>

***RST**

This command resets the power supply to default settings.

Command syntax: *RST

Parameter: None

***SRE**

This command can set the parameter of state byte enable register. Setting parameter can determine which byte value of state byte register is 1 and the byte will set RQS of state byte register to 1. Bit definition of state byte enable register is the same as the state byte register.

Command syntax: *SRE <NR1>

Parameter: 0~255

Query syntax: *SRE?

Returned parameter: <NR1>

***STB?**

This command can read the data from status byte register.

Query syntax: *STB?

Parameter: None

Returned parameter: <NR1>

***TRG**

When power supply trigger source is a command from via BUS, this command will give a trigger signal. And its function is the same as "TRIGger" command.

Query syntax: *TRG

Parameter: None

Returned parameter: None

***SAV**

This command can save the current setups of power supply to specified memory. These setups contain current setups, voltage setups, max voltage set, min voltage set, OVP set, and OCP set. The memory is divided into 8 groups, each contain 1~9 (9 total) setups. Up to 72 setups can be saved in total.

Command syntax: *SAV<NRf>

Parameter: 1~72

***RCL**

This command can recall the setups you saved previously from the specified memory location.

Command syntax: *RCL<NRf>

Parameter: 1~72

5.4 STATUS Subsystem

STATus:QUESTIONable[:EVENT]?

This command can be used to read the value in query event register. After executing this command, the query event register will be cleared.

Query syntax: STATus:QUEStionable[:EVENT]?

Parameter: None

Returned parameter: <NRf>

Relative command: STATus:QUEStionable:ENABLE

The bit definition of query event enable register:

Bit Position	15	14	13	12	11	10	9	8
Bit Name	Not used	Not used	Not used	Not used	Not used	Not used	Not used	Not used
Bit Weight								

Bit Position	7	6	5	4	3	2	1	0
Bit Name	Not used	Not used	Not used	OT	OP	Not used	OC	OV
Bit Weight				16	8		2	1

STATus:QUEStionable:CONDition?

This command is used to read the value of query condition register. When a bit of QUES condition changes, the bit value corresponding in QUEST event register is 1.

Query syntax: STATus:QUEStionable:CONDition?

Parameter: None

Returned parameter: <NRf>

STATus:QUEStionable:ENABLE

This command can set the parameter of quest event enable register. Setting parameter can determine which bit value of quest event register is 1 and the bit will enable QUES.

Command syntax: STATus:QUEStionable:ENABLE <NRf>

Parameter: 0~65535

Default set: Refer to *PSC command

Example: STATus:QUEStionable:ENABLE 128

Query syntax: STATus:QUEStionable:ENABLE?

Returned parameter: <NRf>

5.5 SYSTEM Subsystem

SYSTem:ERRor?

This command is used to query the error information of the power supply. When the error LED lights on the front panel, it tells us that there is one or more hardware or command syntax error happened. There are at most 20 groups of error message. Sending the command once will read one error message from the error queue.

1. Error messages follow the FIFO (first-in-first-out) principle. The first error will be returned first when you read all the error information in the error queue. The ERROR LED will turn off. When an error occurs, the buzzer of the power supply will beep once.
2. If more than 20 errors occurred, the last one stored in the queue will be replaced by “-350”, meaning "too many errors". If the error messages in the queue are not read out, the error following will not be saved to the queue. If there is no error message when reading error information, it will return “0”, meaning “no error”.
3. Turning off the power supply or sending the “CLS” (clear status) command, the error messages in the error queue will be cleared. *RST command will not clear the error messages in the error queue.

Command syntax: SYST:ERR?

Parameter: None

Returned parameter: <NR1>,<SRD>

The following is the error code and the definition:

- (0) No error
- (1) Module Initialization Lost
- (2) Mainframe Initialization Lost
- (3) Module Calibration Lost
- (4) EEPROM failure
- (101) Too many numeric suffices
- (110) No input command
- (114) Invalid Numeric suffix
- (116) Invalid value
- (117) Invalid dimensions
- (120) Parameter overflowed
- (140) Wrong type of parameter
- (150) Wrong number of parameter
- (160) Unmatched quotation mark
- (165) Unmatched bracket
- (170) Invalid command
- (180) No entry in list
- (190) Too many dimensions
- (191) Too many char
- (-200) Execution error
- (-221) Settings conflict
- (-222) Data out of range
- (-223) Too much data
- (-224) Illegal parameter value
- (-225) Out of memory
- (-230) Data Corrupt or Stale
- (-310) System error
- (-350) Too many errors
- (-400) Query error

- (-410) Query INTERRUPTED
- (-420) Query UNTERMINATED
- (-430) Query DEADLOCKED
- (223) Front panel buffer overrun
- (224) Front panel timeout
- (225) Front Crc Check error
- (401) CAL switch prevents
- (402) CAL password is incorrect
- (403) CAL not enabled
- (404) Readback cal are incorrect
- (405) Programming cal are incorrect

SYSTem:VERSion?

This command is used to query the current SCPI version. The returned parameter is a string like "YYYY.V", in which the YYYY is the year of that version, V is the software version of that year.

Command syntax: SYST:VERS?

Parameter: None

Returned parameter: <NRf>

SYSTem:REMOte

This command is used to switch to the remote control mode (PC control). This command is used to set the power supply to remote control mode through the RS232 interface. Except for the Local key on the front panel, other keys are locked and cannot be used. Sending or receiving commands without first sending the command to configure the remote control may cause unpredictable results.

Command syntax: SYST:REM

Parameter: None

SYSTem:LOCal

This command is used to switch the instrument to local control mode (front panel control).

Command syntax: SYST:LOCal

Parameter: None

SYSTem:RWLock

This command is the same function as SYSTem:REMOte, except this command can lock "LOCAL" button as well. When this command is executed, the "Local" button will be disabled.

Command syntax: SYSTem:RWLock

Parameter: None

SYSTem:COMMunicate:GPIB:RDEvice:ADDRess

This command is used to set the GPIB address.

Command syntax: SYSTem:COMMunicate:GPIB:RDEvice:ADDRess <NR1>

Parameters: 0-30

Query syntax: SYSTem:COMMunicate:GPIB:RDEvice:ADDRess?

Return parameter: <NR1>

SYSTem:INTerface

This command is used to select the communication interfaces.

Command syntax: SYSTem:INTerface <GPIB|USB|RS232>

5.6 TRIGGER Subsystem

TRIGger[:IMMediate]

This command is used to create a trigger signal. It will give a trigger signal in BUS trigger source mode. The function is the same as command *TRG.

Command syntax: TRIGger[:IMMediate]

Parameter: None

Related commands: *TRG

TRIGger:SOURce

This command is used to select the trigger source. Power supply can receive trigger signals directly from front panel by pushing “Trigger” button or receive from a BUS trigger signal using *TRG command.

Command syntax: TRIG:SOURce <mode>

Parameter: MANUAL|BUS

Query syntax: TRIGger:SOURce?

Return parameter: MANUAL|BUS

5.7 SOURCE Subsystem

[SOURce:]OUTPut[:STATe]

This command is used to control the output state of the power supply.

Command syntax: [SOURce:]OUTPut [:STATe] <bool>

Parameter: 0|1|ON|OFF

Query syntax: [SOURce:]OUTPut[:STATe]?

Return parameter: 0|1

OUTPut:TIMer

This command is used to set the state of the output timer.

Command syntax: OUTPut:TIMer[:STATe] <bool>

Parameter: 0|1|OFF|ON

Query syntax: OUTPut:TIMer?

OUTPut:TIMer:DATA

This command is used to set the output timer's time.

Command syntax: `OUTPut:TIMer:DATA <NRf>`

Parameter: 0-99999.9

Unit: S

Query syntax: `OUTPut:TIMer:DATA?`

Return parameter: <NRf>

[SOURce:]CURRent[:LEVel][:IMMediate][:AMPLitude]

This command is used to set the output current value. MIN represents 0 A and MAX represents the max value of the current range. CURR? MIN or CURR? MAX commands are used to query the minimum and maximum current of the range. DEF represents the default value and can also be used to set the value. CURR UP and CURR DOWN commands and also be sent to increase or decrease the current. The step value should be set with command "CURR:STEP".

Command syntax: `[SOURce:]CURRent[:LEVel][:IMMediate][:AMPLitude] <NRf>`

Parameter: MIN to MAX|MIN|MAX|UP|DOWN|DEF

Unit: A|mA|uA

Query syntax: `[SOURce:]CURRent[:LEVel][:IMMediate][:AMPLitude]?; CURRent? <MINimum|MAXimum>`

Parameter: None

Return parameter: <NRf>

CURRent:STEP

This command is used to set the step value for CURR UP and CURR DOWN commands.

CURR:STEP? DEF command can query the step resolution of current for this unit. For example, a step value of 0.01 represents 10 mA.

Command syntax: `[SOURce:]CURRent[:LEVel][:IMMediate]:STEP[:INCRement] <NRf>`

Parameter: MIN to MAX

Query command: `CURRent:STEP?`

Return parameter: <NRf>

Example: `CURR:STEP 0.01 //set the step value to be 0.01 A`

`CURR UP //increments output current by 0.01 A`

`CURR:STEP 0.02 //set the step value to be 0.02 A`

`CURR DOWN //decrements output current by 0.02 A`

[SOURce:]CURRent[:LEVel]:TRIGgered[:AMPLitude]{<current level>|MINimum|MAXimum}

This command is used to set a current value to be triggered. This value will be set after the instrument receives a trigger signal. Sending CURRent command will not impact this command's current setting value. Sending a query command will return the original setting value.

Command syntax: `[SOURce:]CURRent[:LEVel]:TRIGgered[:AMPLitude] <NRf>`

Parameter: MIN to MAX|MIN|MAX

Unit: A

Query syntax: `[SOURce:]CURRent[:LEVel]:TRIGgered[:AMPLitude]?`

Return parameter: <NRf>

[SOURce:]CURRENT:PROTECTION[:LEVEL]

This command is used to set the software-current protection value.

Command syntax: [SOURce:]CURRENT:PROTECTION[:LEVEL] <NRf>

Parameter: MIN to MAX|MIN|MAX|DEF

Unit: A |mA| uA

Query syntax: [SOURce:]CURRENT:PROTECTION[:LEVEL]?

Parameter: None

Return parameter: <NRf>

[SOURce:]CURRENT:PROTECTION:STATE

This command is used to set the software-current protection state.

Command syntax: [SOURce:]CURRENT:PROTECTION:STATE<bool>

Parameter: 0|1|ON|OFF

Query syntax: [SOURce:]CURRENT:PROTECTION:STATE?

Parameter: None

Return parameter: 0|1

[SOURce:]VOLTage[:LEVEL][:IMMEDIATE][:AMPLITUDE]

This command is used to set the output voltage value.

Command syntax: [SOURce:]VOLTage[:LEVEL][:IMMEDIATE][:AMPLITUDE] <NRf>

Parameter: MIN TO MAX|MIN|MAX|DEF

Unit: V| mV| uV

Query syntax: [SOURce:]VOLTage[:LEVEL][:IMMEDIATE][:AMPLITUDE]?

Parameter: None

Return parameter: <NRf>

VOLTage {<volts>|MINimum|MAXimum|UP|DOWN|DEF }

This command is used to set the output voltage value. MIN represents 0 V and MAX represents the max value of the voltage range. VOLT? MIN or VOLT? MAX commands are used to query the minimum and maximum current of the range. DEF represents the default value and can also be used to set the value. VOLT UP and VOLT DOWN commands and also be sent to increase or decrease the current. The step value should be set with command "VOLT:STEP".

Command syntax: [SOURce:]VOLTage[:LEVEL][:IMMEDIATE][:AMPLITUDE] <NRf>

Parameter: MIN to MAX|MIN|MAX|UP|DOWN|DEF

Unit: V|mV|uV

Query syntax: [SOURce:]VOLTage[:LEVEL][:IMMEDIATE][:AMPLITUDE]?; VOLTage?

[MINimum|MAXimum]

Return parameter: <NRf>

VOLTage:STEP {<value>|DEFault}

This command is used to set the step value for VOLT UP and VOLT DOWN commands.

VOLT:STEP? DEF command can query the step resolution of current for this unit. For example, a step value of 0.01 represents 10 mV.

Command syntax: [SOURce:]VOLTage[:LEVEL][:IMMEDIATE]:STEP[:INCREMENT] <NRf>

Parameter: MIN to MAX

Query command: VOLTage:STEP?

Return parameter: <NRf>

Example: VOLT:STEP 0.01 //set the step value to be 0.01 V

VOLT UP //increments output current by 0.01 V

VOLT:STEP 0.02 //set the step value to be 0.02 V

VOLT DOWN //decrements output current by 0.02 V

[SOURce:]VOLTage[:LEVel]:TRIGgered[:AMPLitude]{<voltage level> | MINimum | MAXimum}

This command is used to set a voltage value to be triggered. This value will be set when the instrument receives a trigger signal. Sending VOLTage command will not impact this command's voltage setting value. Sending a query command will return the original setting value.

Command syntax: [SOURce:]VOLTage[:LEVel]:TRIGgered[:AMPLitude] <NRf>

Parameter: MIN to MAX | MIN | MAX | DEF

Unit: V | mV | uV

Query syntax: [SOURce:]VOLTage[:LEVel]:TRIGgered[:AMPLitude]?

Return parameter: <NRf>

[SOURce:]VOLTage:PROTection[:LEVel]

This command is used to set the software-voltage protection value.

Command syntax: [SOURce:]VOLTage:PROTection[:LEVel] <NRf>

Parameter: MIN to MAX | MIN | MAX | DEF

Unit: V | mV | uV

Query syntax: [SOURce:]VOLTage:PROTection[:LEVel]?

Parameter: None

Return parameter: <NRf>

[SOURce:]VOLTage:PROTection:STATe

This command is used to set the software-voltage protection state.

Command syntax: [SOURce:]VOLTage:PROTection:STATe<bool>

Parameter: 0 | 1 | ON | OFF

Query syntax: [SOURce:]VOLTage:PROTection:STATe?

Parameter: None

Return parameter: 0 | 1

VOLT:PROTection:TRIP?

This command is used to query the state of OVP. If the return value is "1", this represents that the OVP circuit has been triggered. If the return value is "0", then the OVP circuit has not been triggered.

Command syntax: [SOURce:]VOLTage:PROTection:TRIP?

Return parameter: 0 | 1

VOLT:PROTection:CLear

This command is used to clear the OVP state. Before sending this command, please increase

the upper limit of OVP or reduce the output voltage.

Note: Please remove the device that tripped this protection and then send the command again.

Command syntax: [SOURce:]VOLTage:PROTection:CLear

[SOURce:]VOLTage:LIMIt[:LEVel]<voltage>

This command is used to set the limit of the output voltage.

Command syntax: [SOURce:]VOLTage:LIMIt[:LEVel] <NRf>

Parameter: MIN to MAX|MIN|MAX|DEF

Unit: V| mV| uV

Query syntax: [SOURce:]VOLTage:LIMIt[:LEVel]?

Return parameter: <NRf>

[SOURce:]APPLy {<voltage>|MIN|MAX} [, {<current> |MIN|MAX}]

This command combines two commands in one: "VOLTage, CURRent". APPLy command will only be effective when the setting values are within the range of the upper voltage and current limits.

Command syntax: [SOURce:]APPLy <NRf>,<NRf>

Parameter: MIN to MAX|MIN|MAX

Unit: V, A

Query syntax: [SOURce:]APPLy?

Return parameter: <NRf>,<NRf>

Example: APPL 5,2 //sets output voltage to 5 V and output current to 2 A

5.8 MEASUREMENT Commands

MEASure[:SCALar]:VOLTage[:DC]?

This command is used to query the actual output voltage.

Command syntax: MEASure[:SCALar]:VOLTage[:DC]?

Parameter: None

Return parameter: <NRf>

Return parameter unit: V

Example: MEAS:VOLT?

FETCh:VOLTage?

This command is used to read the voltage to be handled in the sample cache. After sending the command, the readings will be sent to the computer. This command does not affect the instrument settings. This command does not trigger a measurement operation, and queries only the latest available reading. Before reading the new reading, the command returns old readings.

Command syntax: FETCh:VOLTage?

Return parameter: <NRf>

Return parameter unit: V

MEASure[:SCALar]:CURRent[:DC]?

This command is used to read the actual current.

Command syntax: MEASure[:SCALar]:CURRent[:DC]?

Parameter: None

Return parameter: <NRf>

Return parameter unit: A

Example: MEAS:CURR?

FETCh:CURRent?

This command is used to read the current which is in the sample cache. After sending the command, the readings will be sent to the computer. This command does not affect the instrument settings. This command does not trigger a measurement operation, and queries only the latest available reading. Before reading the new reading, the command returns the old readings.

Command syntax: FETCh:CURRent?

Return parameter: <NRf>

MEASure[:SCALar]:POWer[:DC]?

This command is used to query the actual output power.

Command syntax: MEASure[:SCALar]:POWer[:DC]?

Parameter: None

Return parameter: <NRf>

Return parameter unit: W

Example: MEAS:POWer?

FETCh:POWer?

This command is used to read the power which is in the sample cache. After sending the command, the readings will be sent to the computer. This command does not affect the instrument settings. This command does not trigger a measurement operation, and queries only the latest available reading. Before reading the new reading, the command returns the old readings.

Command syntax: FETCh:POWer?

Return parameter: <NRf>

MEASure:DVM?

This command is used to read the latest measured value of the DVM meter.

Command syntax: MEASure[:SCALar]:DVM[:DC]?

Return parameter: <NRf>

FETCh:DVM?

This command is used to read the latest data of DVM meter from the sampling buffer.

Command syntax: FETCh:DVM[:DC]?

Return parameter: <NRf>

MEASure:STATus?

This command is used to switch the display of VFD board between actual output state and DVM state.

Command syntax: MEASure[:SCALar]:STATus <DVM|NORMAL>

5.9 LIST Commands

LIST:FUNction

This command is used to set the state of list mode.

Command syntax: [SOURce:]LIST:FUNction <0|1>

Query syntax: [SOURce:]LIST:FUNction?

Return parameter: 0|1

LIST:VOLTage

This command is used to set the steps of list file and voltage of current step.

Command syntax: [SOURce:]LIST:VOLTage <NRf>

Parameter: MIN to MAX

Unit: V

Query syntax: LIST:VOLTage?

Return parameter: <NRf>

Example: LIST:VOLT 1,3V //set the first step's voltage to be 3 V

LIST:VOLT? 1 //query the first step's voltage

LIST:CURREnt

This command is used to set the steps of list file and current value of current step.

Command syntax: [SOURce:]LIST:CURREnt <NRf>

Parameter: MIN to MAX

Unit: A

Query syntax: LIST:CURREnt?

Return parameters: <NRf>

Example: LIST:CURR 1,2A //set the first step's current to be 2 A

LIST:CURR? 1 //query the first step's current

LIST:TIMEr

This command is used to set the steps of list file and delay time of current step.

This command is used to set delay time of each step.

Command syntax: [SOURce:]LIST:TIMEr

Parameters: MIN to MAX|MIN|MAX

Unit: S

Query syntax: LIST:TIMEr? <NR1>

Return parameters: <NRf>

Example: LIST:TIME 1,3 //set the first step's time to be 3 S

LIST:TIME? 1 //query the first step's delay time

LIST:LOAD

This command can recall the list file saved before from specified memory region. Sending query commands can inquire which group file you have recalled.

Command syntax: [SOURce:]LIST:LOAD[:IMMEDIATE] <NR1>

Parameters: 0 to 9

Query syntax: LIST:LOAD[:IMMEDIATE]?

Return parameters: <NR1>

Example: LIST:LOAD 1

LIST:REP

This command can set the repeat count of LIST steps.

Command syntax: [SOURce:]LIST:REP <NR1>

Parameters: 1-65535

Query syntax: LIST:REP?

Return parameter: 1-65535

LIST:SAVE

This command is used to save the list file in non-volatile memory.

Command syntax: LIST:SAVE <NR1>

Parameter: 0 to 9

Return parameter: <NR1>

6 Troubleshooting Guide

Below are some frequently asked questions and answers. Please check if any apply to your power supply before contacting B&K Precision.

General

Q: I cannot power up the power supply.

- Check that the power cord is securely connected to the AC input and there is live power from your electrical AC outlet.
- Verify that the AC power coming from the mains contains the correct voltage. The power supply can accept a specific range of AC input voltages. Refer to section 2.1.

Q: How do I set up the supply to run in constant current mode?

- The supply is a CV/CC power supply that automatically crosses over from CV to CC upon a load which draws current at the current limit (ISET). Therefore, it is dependent on the load. For example, if ISET is configured as 1 A, the load must draw 1 A before the supply will go into CC mode.

Q: How come my display voltage is lower than the voltage I set?

- This is often because of the resistances from the test leads/wires connected between the supply and the DUT (device under test), which causes a drop in voltage. To minimize this drop, use remote sense terminals to compensate and output a more accurate voltage to the DUT.

Q: I cannot set voltage at the maximum rating.

- This may be that the set voltage is outside of the voltage maximum limit. Refer to “Voltage Limit SettingError! Reference source not found.” section to verify and configure the limits.

Remote Control

Q: I am trying to send the commands over RS232, but it does not seem to respond.

- Check that you are sending ASCII strings that are terminated with a CR (carriage return) and LF (linefeed) character.
- For RS-232, check that the baud rate, parity, data bits, stop bit, and flow control settings match with the settings configured on the software interface.

7 Specifications

Note: All specifications apply to the unit after a temperature stabilization time of 15 minutes over an ambient temperature range of $23\text{ }^{\circ}\text{C} \pm 5\text{ }^{\circ}\text{C}$. Specifications are subject to change without notice.

Environmental Conditions:

This power supply is designed for indoor use and operated with maximum relative humidity of 80%.

Model	9201	9202	9205	9206
Output Rating				
Voltage	0-60 V	0-60 V	0-60 V	0-150 V
Current	0-10 A	0-15 A	0-25 A	0-10 A
Power	200 W	360 W	600 W	600 W
Line Regulation				
Voltage	$\leq 0.01\% + 5\text{ mV}$	$\leq 0.01\% + 8\text{ mV}$	$\leq 0.01\% + 15\text{ mV}$	$\leq 0.01\% + 15\text{ mV}$
Current	$\leq 0.05\% + 4\text{ mA}$	$\leq 0.05\% + 6\text{ mA}$	$\leq 0.1\% + 10\text{ mA}$	$\leq 0.05\% + 10\text{ mA}$
Load Regulation				
Voltage	$\leq 0.01\% + 8\text{ mV}$	$\leq 0.01\% + 8\text{ mV}$	$\leq 0.01\% + 15\text{ mV}$	$\leq 0.01\% + 15\text{ mV}$
Current	$\leq 0.05\% + 6\text{ mA}$	$\leq 0.05\% + 6\text{ mA}$	$\leq 0.1\% + 10\text{ mA}$	$\leq 0.05\% + 10\text{ mA}$
Ripple and Noise (20Hz-20MHz)				
Voltage	$\leq 8\text{ mVpp}$	$\leq 15\text{ mVpp}$	$\leq 20\text{ mVpp}$	$\leq 50\text{ mVpp}$
Current	$\leq 6\text{ mArms}$	$\leq 8\text{ mArms}$	$\leq 15\text{ mArms}$	$\leq 15\text{ mArms}$
Programming Resolution				
Voltage	1 mV	1 mV	1 mV	1 mV
Current	0.1 mA	0.1 mA	0.1 mA	0.1 mA
Readback Resolution				
Voltage	1 mV	1 mV	1 mV	1 mV
Current	0.1 mA	0.1 mA (<10 A) 1 mA (>10 A)	0.1 mA (<10 A) 1 mA (>10 A)	0.1 mA
Programming Accuracy \pm (%output+offset)				
Voltage	$\leq 0.03\% + 5\text{ mV}$	$\leq 0.03\% + 5\text{ mV}$	$\leq 0.03\% + 5\text{ mV}$	$\leq 0.03\% + 20\text{ mV}$
Current	$\leq 0.1\% + 10\text{ mA}$	$\leq 0.1\% + 15\text{ mA}$	$\leq 0.1\% + 25\text{ mA}$	$\leq 0.1\% + 25\text{ mA}$
Readback Accuracy \pm (%output+offset)				
Voltage	$\leq 0.03\% + 5\text{ mV}$	$\leq 0.03\% + 5\text{ mV}$	$\leq 0.03\% + 5\text{ mV}$	$\leq 0.03\% + 20\text{ mV}$
Current	$\leq 0.1\% + 10\text{ mA}$	$\leq 0.1\% + 15\text{ mA}$	$\leq 0.1\% + 25\text{ mA}$	$\leq 0.1\% + 25\text{ mA}$

General		
Remote Sense Compensation	1 V	
DVM Range	0-60 V	
DVM Accuracy	0.02%+10 mV	
DVM Resolution	1 mV	
Standard Interface	USB (USBTMC-compliant), GPIB, RS-232	
AC Input	110/220 VAC (+/- 10 %), 47 Hz - 63 Hz	
Operating Temperature	32 °F to 104 °F (0 °C to 40 °C)	
Storage Temperature	-4 °F to 158 °F (-20 °C to 70 °C)	
Dimensions (W×H×D)	8.45" x 3.47" x 13.96" (214.5 x 88.2 x 354.6 mm)	8.45" x 3.47" x 17.52" (214.5 x 88.2 x 445 mm)
Weight	16.98 lbs. (7.7 kg)	33.07 lbs. (15 kg)

To ensure the most current version of this manual, please visit www.bkprecision.com.

8 Calibration

We recommend a calibration interval of once per year to ensure that the power supply meets specifications.

SERVICE INFORMATION

Warranty Service: Please go to the support and service section on our website at www.bkprecision.com to obtain a RMA #. Return the product in the original packaging with proof of purchase to the address below. Clearly state on the RMA the performance problem and return any leads, probes, connectors and accessories that you are using with the device.

Non-Warranty Service: Please go to the support and service section on our website at www.bkprecision.com to obtain a RMA #. Return the product in the original packaging to the address below. Clearly state on the RMA the performance problem and return any leads, probes, connectors and accessories that you are using with the device. Customers not on an open account must include payment in the form of a money order or credit card. For the most current repair charges please refer to the service and support section on our website.

Return all merchandise to B&K Precision Corp. with prepaid shipping. The flat-rate repair charge for Non-Warranty Service does not include return shipping. Return shipping to locations in North America is included for Warranty Service. For overnight shipments and non-North American shipping fees please contact B&K Precision Corp.

B&K Precision Corp.
22820 Savi Ranch Parkway
Yorba Linda, CA 92887
www.bkprecision.com
714-921-9095

Include with the returned instrument your complete return shipping address, contact name, phone number and description of problem.

LIMITED THREE-YEAR WARRANTY

B&K Precision Corp. warrants to the original purchaser that its products and the component parts thereof, will be free from defects in workmanship and materials for a period of **three years** from date of purchase.

B&K Precision Corp. will, without charge, repair or replace, at its option, defective product or component parts. Returned product must be accompanied by proof of the purchase date in the form of a sales receipt.

To help us better serve you, please complete the warranty registration for your new instrument via our website www.bkprecision.com

Exclusions: This warranty does not apply in the event of misuse or abuse of the product or as a result of unauthorized alterations or repairs. The warranty is void if the serial number is altered, defaced or removed.

B&K Precision Corp. shall not be liable for any consequential damages, including without limitation damages resulting from loss of use. Some states do not allow limitations of incidental or consequential damages. So the above limitation or exclusion may not apply to you.

This warranty gives you specific rights and you may have other rights, which vary from state-to-state.

B&K Precision Corp.
22820 Savi Ranch Parkway
Yorba Linda, CA 92887
www.bkprecision.com
714-921-9095



22820 Savi Ranch Parkway
Yorba Linda, CA 92887
www.bkprecision.com

© 2014 B&K Precision Corp.