

GlobTek, Inc.
 www.globtek.com
 186 Veterans Drive,
 Northvale, NJ 07647
 Tel. (201) 784-1000
 Fax (201) 784-0111

Drawing Title: GTM46402-4019, Medical/ITE/Household use Power Supply, Efficiency Level: VI, Case Color/Style: GlobTek Black, Wall Plug-in, Regulated Switchmode AC-DC Power Supply AC Adaptor, Input Rating: 100-240V~, 50-60 Hz, Interchangeable Blades <http://en.globtek.com/interchangeable-blades.php>, Output Rating: 40W, 19V@2.1A, Output Configuration: 1200 mm, 16/2 Cond, UL 2468, Female Barrel 5.5 * 2.5 * 11mm with internal Spring Clip and Locking Notch or Equal, Ferrite: None, GlobTek Black, GT Cord # C3039, Pin Out: Center Positive (+V), Blades/Input Cord: Q-Series N. American, Approvals: PSE CB CB cETLus 60950 CB cETLus UL1310 UL SELV CB EAC LPS 2MOPP SG (13.2V) CCC CE Ukraine VCCI RoHS Level VI FCC CAN ICES-3 IP52 Double Insulation WEEE

Model No. GTM46402-4019

Part No./Ordering No. WR9QH2100LCPNNAR6B

Rev A

REVISION HISTORY

REV	DESCRIPTION	SUB	DATE	APPROVED
A	Initial release	rchiu	12/29/2017	QA

In Addition to GlobTek Inc.'s renewed ISO9001:2008 - Quality Management System Certification, GlobTek Inc. is now certified to:

ISO13485:2003 - Medical Devices Quality Management System Certification
 ISO14001:2004 - Environmental Management System Certification

ISO Certificates are available online at <http://www.globtek.com/iso-certificates/>

Customer Approval of Specification:

Please approve, sign and send back to GlobTek so we can complete order processing.

A delay in receipt of this form will delay delivery schedule.

Company Name:

Customer P/N:

Quote Number:

Date:

Authorized Representative Name:

Authorized Representative Signature:

The acceptance of this specification and use of the product described in this document indicates the acceptance and binding of the customer to Globtek terms and conditions, which supersede all other agreements, terms, and conditions (<http://en.globtek.com/terms-and-conditions/>).

Footnote:

GlobTek Inc. will not be liable for the safety and performance of these power supplies if unauthorized access and repair occurs. End user should consult applicable UL, CSA or EN standards for proper installation instruction.

Limitation of Use:

GlobTek product are not authorized for use as mission critical components in life support hazardous environment, nuclear or aircraft applications without prior written approval from the CEO of GlobTek Inc.

Contents of this document are subject to change without prior notice.

GTM46402-4019, 40W, 19V@2.1A, Wall Plug-in, Regulated Switchmode AC-DC Power Supply AC Adaptor

GlobTek, Inc.
www.globtek.com
186 Veterans Drive,
Northvale, NJ 07647
Tel. (201) 784-1000
Fax (201) 784-0111

Drawing Title: GTM46402-4019, Medical/ITE/Household use Power Supply, Efficiency Level: VI, Case Color/Style: GlobTek Black, Wall Plug-in, Regulated Switchmode AC-DC Power Supply AC Adaptor, Input Rating: 100-240V~, 50-60 Hz, Interchangeable Blades <http://en.globtek.com/interchangeable-blades.php>, Output Rating: 40W, 19V@2.1A, Output Configuration: 1200 mm, 16/2 Cond, UL 2468, Female Barrel 5.5 * 2.5 * 11mm with internal Spring Clip and Locking Notch or Equal, Ferrite: None, GlobTek Black, GT Cord # C3039, Pin Out: Center Positive (+V), Blades/Input Cord: Q-Series N. American, Approvals: PSE CB CB cETLus 60950 CB cETLus UL1310 UL SELV CB EAC LPS 2MOPP SG (13.2V) CCC CE Ukraine VCCI RoHS Level VI FCC CAN ICES-3 IP52 Double Insulation WEEE

Model No. GTM46402-4019

Part No./Ordering No. WR9QH2100LCPNNAR6B

Rev A

POWER SUPPLY INFORMATION

TYPE: Wall Plug-in
TECHNOLOGY: Regulated Switchmode AC-DC Power Supply AC Adaptor
CASE COLOR: GlobTek Black
NAMEPLATE RATED INPUT: 100-240V~, 50-60 Hz, 1.0A
INPUT CONFIG: Interchangeable Blades
WATTS: 40.0
VOLTS OUT: 19
CURRENT OUT (Amps): 2.1
BLADE/CORD INCLUDED: Q-NA(R):
BLADE/CORD INSTALLED: Q-NA(R):
GROUNDING CONFIGURATION (F1) Class II / Double Insulated
EFFICIENCY LEVEL: VI
OUTPUT CONFIGURATION 1200 mm, 16/2 Cond, UL 2468, Female Barrel 5.5 * 2.5 * 11mm with internal Spring Clip and Locking Notch or Equal,
CONNECTOR PIN OUT: Center Positive (+V)
LABEL SPECS: Standard GT,L-1186
PACK SPEC: Standard WPI Q-NA installed, Individually Box

Notes/Modifications/Customizations (notes in this section supersede the values shown in the standard spec):

DIMENSIONS ARE IN MM UNLESS SPECIFIED OTHERWISE.

GloTek, Inc. www.globtek.com 186 Veterans Drive, Northvale, NJ 07647 Tel. (201) 784-1000 Fax (201) 784-0111	Drawing Title: GTM46402-4019, Medical/ITE/Household use Power Supply, Efficiency Level: VI, Case Color/Style: GlobTek Black, Wall Plug-in, Regulated Switchmode AC-DC Power Supply AC Adaptor, Input Rating: 100-240V~, 50-60 Hz, Interchangeable Blades http://en.globtek.com/interchangeable-blades.php , Output Rating: 40W, 19V@2.1A, Output Configuration: 1200 mm, 16/2 Cond, UL 2468, Female Barrel 5.5 * 2.5 * 11mm with internal Spring Clip and Locking Notch or Equal, Ferrite: None, GlobTek Black, GT Cord # C3039, Pin Out: Center Positive (+V), Blades/Input Cord: Q-Series N. American, Approvals: PSE CB CB cETLus 60950 CB cETLus UL1310 UL SELV CB EAC LPS 2MOPP SG (13.2V) CCC CE Ukraine VCCI RoHS Level VI FCC CAN ICES-3 IP52 Double Insulation WEEE	
	Model No. GTM46402-4019	
	Part No./Ordering No. WR9QH2100LCPNNAR6B	Rev A

ELECTRICAL SPECIFICATIONS

A) ELECTRICAL SPECIFICATIONS:

01. Input Voltage: Specified 90-264 Vac, Nameplate rated: 100-240Vac
 - 90-264 Vac range @ 100% of rated load current
 - 85-264 Vac range @ 85% of rated load current
 - 110-370 VDC range @ 100% of rated load current
02. Input Frequency: Specified 47-63 Hz, Nameplate rated 50-60Hz
03. Output Regulation: +/- 5% measured at the output connector
04. Line Voltage Regulation: +/- 0.5% typical measured at full load
05. Output Ripple (Vp-p): 1% or 100 mV whichever is greater, measured at 20 MHz bandwidth with 0.1 uf ceramic capacitor in parallel with a low impedance 47 uf electrolytic capacitor connected at the end of the output connector
06. Turn-ON/OFF Overshoot: 5% maximum, 1 mS typical recovery time for 40% to 70% step load
07. Turn-ON Delay: 1 second maximum @ full load, nominal line
08. Hold-Up Time: 8 mS typical @ nominal input voltage and full load
09. Inrush Current: 30A/60A maximum cold start @ 115/230Vac input
10. Efficiency: Compliant with Efficiency Level VI and CoC Tier 2 standards
11. No Load Standby Power: <0.075 W @ 230Vac

B) PROTECTION

01. Input Protection: Input line fusing and 300Vac MOV
02. Short Circuit/ Overload: Electronically Protected unit will auto recover upon removal of fault
 - Output Current Limit: 110% to 160% of rated output current
 - (upper end of current limit range is determined by normal output power rating, not derated output power level)
03. Output Over-Voltage: 110% to 130% of nominal output voltage

C) SAFETY

01. Dielectric Withstand Voltage: 4000Vac or 5656Vdc from input to output
02. Earth Leakage Current: N/A for Class II models
03. Touch Current: < 95uA
04. Means of Protection for Medical Standard: 2 x MOPP
05. Compliant Standards: See listings at end of this drawing for specifics

D) EMC

EN 60601-1-2, 4th edition
Emissions, per EN 55032, EN 61000-6-3, EN 61000-6-4
Conducted Emissions: Class B, FCC Part 15, Class B
Radiated Emissions: Class B, FCC Part 15, Class B
Line Frequency Harmonics EN61000-3-2, Class A
Voltage Fluctuations/Flicker EN61000-3-3

Immunity, per EN 55024, EN 61000-6-1, EN 61000-6-2
Static Discharge Immunity EN61000-4-2, 10kV Contact Discharge, 20kV air discharge
Radiated RF Immunity EN61000-4-3, 10V/m 80-1000MHz, 3V/m 1-2.7GHz, 80% 1KHz AM.
EFT/Burst Immunity EN61000-4-4, 4kV/100kHz.
Line Surge Immunity EN61000-4-5, 2kV differential, 4kV common-mode
Conducted RF Immunity EN61000-4-6, 3Vrms, 80% 1KHz AM
Power Frequency Magnetic Field Immunity EN61000-4-8, 3A/m
Voltage Dip Immunity EN61000-4-11, Criteria

E) OTHER:

01. MTBF: 1,000,000 Hours @ 40°C ambient temperature, Full Load
 - Projected failure rate expected to be < 0.5% after 5 years, < 3 % after 10 years
02. Operating Temperature: -20°C to 40°C ambient temperature at full load, -40°C to 50°C ambient temperature with derating to 80% load
03. Operating Humidity: 0% to 95% relative humidity, non-condensing
04. Storage Temperature: -30°C to 80°C
05. Operating Altitude: 5000 Meters for IEC 62368-1 and IEC 60335-1. 3000M for IEC 60601-1
06. Ingress Protection: IP40 standard, IP52 available as special option
07. ROHS: Compliant with latest regulations, see approvals section below

F) ENCLOSURE

PROPRIETARY INFORMATION

PROPRIETARY OF GLOBTEK, INC. ANY REPRODUCTION, DISCLOSURE OR USE OF THIS DRAWING, IN WHOLE OR IN PART, IS HEREBY PROHIBITED EXCEPT AS SPECIFIED IN WRITING BY GLOBTEK, INC.

GlobTek, Inc.
www.globtek.com
186 Veterans Drive,
Northvale, NJ 07647
Tel. (201) 784-1000
Fax (201) 784-0111

Drawing Title: GTM46402-4019, Medical/ITE/Household use Power Supply, Efficiency Level: VI, Case Color/Style: GlobTek Black, Wall Plug-in, Regulated Switchmode AC-DC Power Supply AC Adaptor, Input Rating: 100-240V~, 50-60 Hz, Interchangeable Blades <http://en.globtek.com/interchangeable-blades.php>, Output Rating: 40W, 19V@2.1A, Output Configuration: 1200 mm, 16/2 Cond, UL 2468, Female Barrel 5.5 * 2.5 * 11mm with internal Spring Clip and Locking Notch or Equal, Ferrite: None, GlobTek Black, GT Cord # C3039, Pin Out: Center Positive (+V), Blades/Input Cord: Q-Series N. American, Approvals: PSE CB CB cETLus 60950 CB cETLus UL1310 UL SELV CB EAC LPS 2MOPP SG (13.2V) CCC CE Ukraine VCCI RoHS Level VI FCC CAN ICES-3 IP52 Double Insulation WEEE

Model No. GTM46402-4019

Part No./Ordering No. WR9QH2100LCPNNAR6B

Rev A

- 01. Housing: High impact plastic, 94V0 polycarbonate, non-vented
- 02. Markings: Label or Laser Printed
- 03. AC Input mechanical: Replaceable, Class II Wall Plug-in attachments

G) SPECIAL OPTIONS

- 02. Custom Cordsets, various cordage types, and connector types*
- 03. Custom Markings
- 06. Tightened output voltage tolerance
- 07. Reduced output ripple level
- 08. Reduced output power rating marking
- 09. High Rel PCB laminate with Plated through Holes for IPC610 Class 2 Compliance
- 10. Special Housing Colors and Cordset Colors

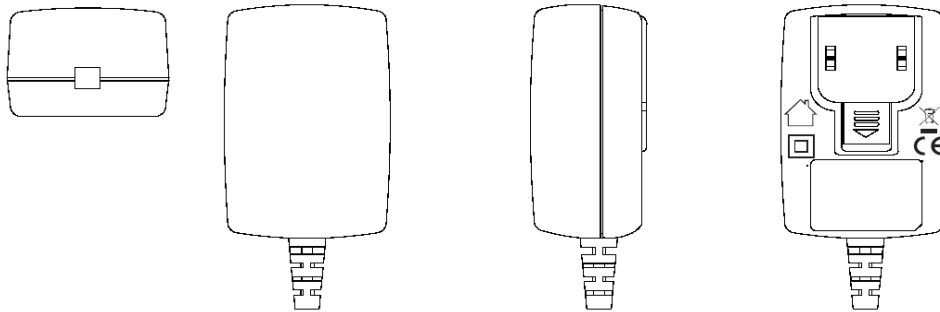

DERATING CURVE

GlobTek, Inc.
 www.globtek.com
 186 Veterans Drive,
 Northvale, NJ 07647
 Tel. (201) 784-1000
 Fax (201) 784-0111

Drawing Title: GTM46402-4019, Medical/ITE/Household use Power Supply, Efficiency Level: VI, Case Color/Style: GlobTek Black, Wall Plug-in, Regulated Switchmode AC-DC Power Supply AC Adaptor, Input Rating: 100-240V~, 50-60 Hz, Interchangeable Blades <http://en.globtek.com/interchangeable-blades.php>, Output Rating: 40W, 19V@2.1A, Output Configuration: 1200 mm, 16/2 Cond, UL 2468, Female Barrel 5.5 * 2.5 * 11mm with internal Spring Clip and Locking Notch or Equal, Ferrite: None, GlobTek Black, GT Cord # C3039, Pin Out: Center Positive (+V), Blades/Input Cord: Q-Series N. American, Approvals: PSE CB CB cETLus 60950 CB cETLus UL1310 UL SELV CB EAC LPS 2MOPP SG (13.2V) CCC CE Ukraine VCCI RoHS Level VI FCC CAN ICES-3 IP52 Double Insulation WEEE

Model No. GTM46402-4019

Part No./Ordering No. WR9QH2100LCPNNAR6B

Rev A

Typical External Power Supply Derating Curve

(For Efficiency Level V and Efficiency Level VI Products)

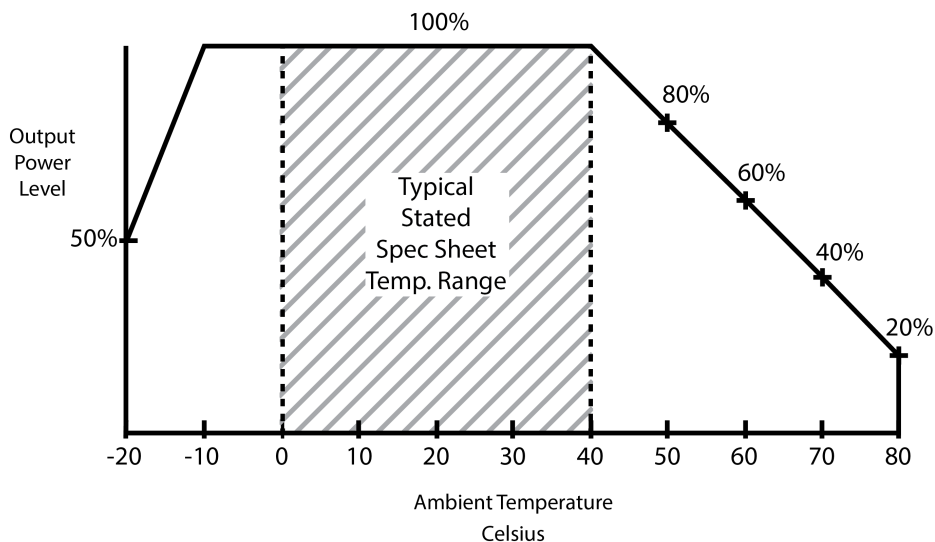

GlobTek, Inc.
 www.globtek.com
 186 Veterans Drive,
 Northvale, NJ 07647
 Tel. (201) 784-1000
 Fax (201) 784-0111

Drawing Title: GTM46402-4019, Medical/ITE/Household use Power Supply, Efficiency Level: VI, Case Color/Style: GlobTek Black, Wall Plug-in, Regulated Switchmode AC-DC Power Supply AC Adaptor, Input Rating: 100-240V~, 50-60 Hz, Interchangeable Blades <http://en.globtek.com/interchangeable-blades.php>, Output Rating: 40W, 19V@2.1A, Output Configuration: 1200 mm, 16/2 Cond, UL 2468, Female Barrel 5.5 * 2.5 * 11mm with internal Spring Clip and Locking Notch or Equal, Ferrite: None, GlobTek Black, GT Cord # C3039, Pin Out: Center Positive (+V), Blades/Input Cord: Q-Series N. American, Approvals: PSE CB CB cETLus 60950 CB cETLus UL1310 UL SELV CB EAC LPS 2MOPP SG (13.2V) CCC CE Ukraine VCCI RoHS Level VI FCC CAN ICES-3 IP52 Double Insulation WEEE

Model No. GTM46402-4019

Part No./Ordering No. WR9QH2100LCPNNAR6B

Rev A

INPUT CONFIGURATION

Grounding Configuration:

Blades/Cord Included: Q-NA(R):

Blades/Cord Installed: Q-NA(R):

Blade Options for Q Series Wall Plug-in Power Supplies

Data Sheet: <http://en.globtek.com/interchangeable-blades.php>

Insertion Instructions: <http://www.globtek.com/pdf/Instructions-Interchangeable-Blades.pdf>

Video: [Q-Blade Style Instruction Video](#)

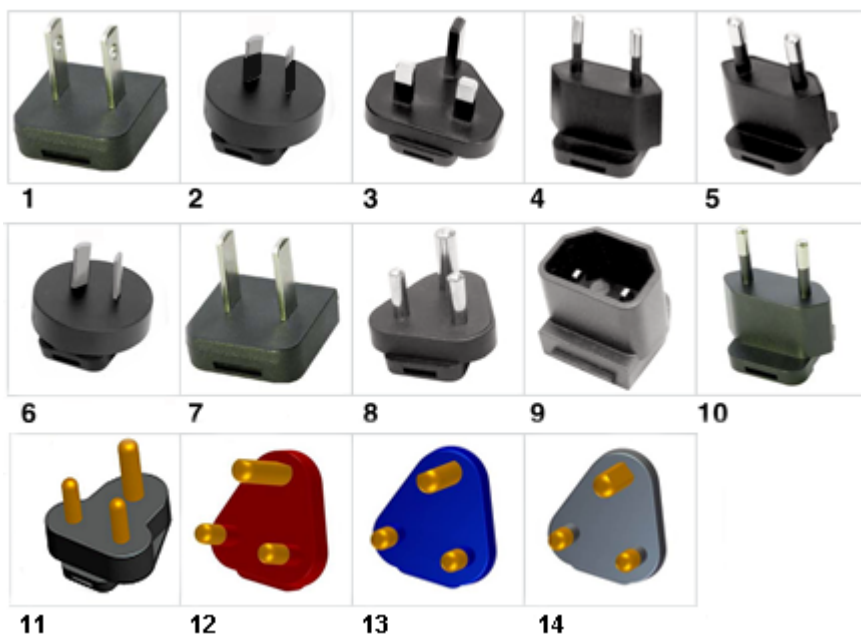

INPUT CONNECTOR: Q-Socket (below are available blades configurations which are "not included" (unless stated above); can be purchased separately, package with power supply or as a separate "Q-KIT" if specified

01. United States / Canada / Japan NEMA 1-15P configuration: NA 2 blades, Class II; US/CA/JP P/N: Q-NA(R)
02. Australian AS 3112 configuration: SAA 2 blade, Class II; AU P/N: Q-SAA(R)
03. UK BS 1363 configuration: UK 3 blade with dummy Ground, Class II; GB P/N: Q-UK(R)
04. European CEE 7/16 configuration: Europlug 2 pins, Class II; EU P/N: Q-EU(R)
05. Korean KS C8305 configuration: 2 pins, Class II; KR P/N: Q-KR(R)
06. Argentina IRAM 2073 configuration: 2 blades; AR P/N: Class II Q-AR(R)
07. China GB 2099 configuration: 2 blades, Class II; CN P/N: Q-CN(R)
08. India IS 1293 6A/BS546 configuration: 5A, 3 pins with Dummy Ground, Class II; IN P/N: Q-IN(R)
09. IEC320/C18 Inlet, Class II; P/N: Q-C18(R)
10. Brazilian NBR6147 configuration: 2 pins, Class II; BR P/N: Q-BR(R)
11. South Africa SABS164-1, 3 round prongs, Class II + dummy ground, P/N: Q-SANS164-1-16A(R)
12. South Africa SABS164-4, 3 round prongs with a notched prong @ 0°, Class II + dummy ground, Red, P/N: Q-SANS164-4L-16A(R)
13. South Africa SABS164-4, 3 round prongs with a notched prong @ -53°, Class II + dummy ground, Blue, P/N:

GlobTek, Inc.
www.globtek.com
186 Veterans Drive,
Northvale, NJ 07647
Tel. (201) 784-1000
Fax (201) 784-0111

Drawing Title: GTM46402-4019, Medical/ITE/Household use Power Supply, Efficiency Level: VI, Case Color/Style: GlobTek Black, Wall Plug-in, Regulated Switchmode AC-DC Power Supply AC Adaptor, Input Rating: 100-240V~, 50-60 Hz, Interchangeable Blades <http://en.globtek.com/interchangeable-blades.php>, Output Rating: 40W, 19V@2.1A, Output Configuration: 1200 mm, 16/2 Cond, UL 2468, Female Barrel 5.5 * 2.5 * 11mm with internal Spring Clip and Locking Notch or Equal, Ferrite: None, GlobTek Black, GT Cord # C3039, Pin Out: Center Positive (+V), Blades/Input Cord: Q-Series N. American, Approvals: PSE CB CB cETLus 60950 CB cETLus UL1310 UL SELV CB EAC LPS 2MOPP SG (13.2V) CCC CE Ukraine VCCI RoHS Level VI FCC CAN ICES-3 IP52 Double Insulation WEEE

Model No. GTM46402-4019

Part No./Ordering No. WR9QH2100LCPNNAR6B

Rev A

Q-SANS164-4C-16A(R)

14. South Africa SABS164-4, 3 round prongs with a notched prong @ +53°, Class II + dummy ground, Black, P/N:

Q-SANS164-4R-16A(R)

Kits

01. Q-KIT: 1,2,3,4 above
02. Q-KIT-INTL: 2,3,4 above
03. Q-KIT-6: 1,2,3,4,5,6 above
04. Q-KIT-7: 1,2,3,4,5,6,7 above
05. Q-KIT-8: 1,2,3,4,5,6,7,8 above

GlobTek, Inc.
www.globtek.com
186 Veterans Drive,
Northvale, NJ 07647
Tel. (201) 784-1000
Fax (201) 784-0111

Drawing Title: GTM46402-4019, Medical/ITE/Household use Power Supply, Efficiency Level: VI, Case Color/Style: GlobTek Black, Wall Plug-in, Regulated Switchmode AC-DC Power Supply AC Adaptor, Input Rating: 100-240V~, 50-60 Hz, Interchangeable Blades <http://en.globtek.com/interchangeable-blades.php>, Output Rating: 40W, 19V@2.1A, Output Configuration: 1200 mm, 16/2 Cond, UL 2468, Female Barrel 5.5 * 2.5 * 11mm with internal Spring Clip and Locking Notch or Equal, Ferrite: None, GlobTek Black, GT Cord # C3039, Pin Out: Center Positive (+V), Blades/Input Cord: Q-Series N. American, Approvals: PSE CB CB cETLus 60950 CB cETLus UL1310 UL SELV CB EAC LPS 2MOPP SG (13.2V) CCC CE Ukraine VCCI RoHS Level VI FCC CAN ICES-3 IP52 Double Insulation WEEE

Model No. GTM46402-4019

Part No./Ordering No. WR9QH2100LCPNNAR6B

Rev A

OUTPUT CORD AND CONNECTOR: LCL/C3039

ACTUAL CONNECTORS, OVERMOLDS, FERRITES MAY VARY SLIGHTLY FROM THE PICTURE BELOW

CABLE TYPE	UL 2468
CABLE LENGTH (mm)	1200
CABLE TOLERANCE (mm)	+100-0
WIRE GAUGE (AWG)	16
CONDUCTORS	2
HANK DIMENSION (mm)	90 ± 10
CABLE / CONNECTOR OVERMOLD COLOR	GlobTek Black
FERRITE TYPE / DIMENSION	None
FERRITE # OF TURNS (Definition)	N/A
FERRITE DIMENSION FROM STRAIN RELIEF	N/A
FERRITE DIMENSION FROM PLUG	N/A
PLUG TYPE	Female Barrel 5.5 * 2.5 * 11mm with internal Spring Clip and Locking Notch or Equal
OVER MOLD ORIENTATION	Straight
CONNECTOR PIN OUT:	Center Positive (+V)
ADDITIONAL REQUIREMENTS	

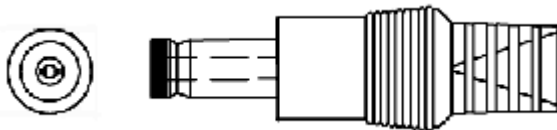

ADDITIONAL OUTPUT PLUG OPTIONS ARE AVAILABLE AT <http://www.globtek.com/connectors/>
STANDARD PLUGS AND CONNECTORS CAN BE SEEN ONLINE AT <http://www.globtek.com/connectors/>

GlobTek, Inc.
 www.globtek.com
 186 Veterans Drive,
 Northvale, NJ 07647
 Tel. (201) 784-1000
 Fax (201) 784-0111

Drawing Title: GTM46402-4019, Medical/ITE/Household use Power Supply, Efficiency Level: VI, Case Color/Style: GlobTek Black, Wall Plug-in, Regulated Switchmode AC-DC Power Supply AC Adaptor, Input Rating: 100-240V~, 50-60 Hz, Interchangeable Blades <http://en.globtek.com/interchangeable-blades.php>, Output Rating: 40W, 19V@2.1A, Output Configuration: 1200 mm, 16/2 Cond, UL 2468, Female Barrel 5.5 * 2.5 * 11mm with internal Spring Clip and Locking Notch or Equal, Ferrite: None, GlobTek Black, GT Cord # C3039, Pin Out: Center Positive (+V), Blades/Input Cord: Q-Series N. American, Approvals: PSE CB CB cETLus 60950 CB cETLus UL1310 UL SELV CB EAC LPS 2MOPP SG (13.2V) CCC CE Ukraine VCCI RoHS Level VI FCC CAN ICES-3 IP52 Double Insulation WEEE

Model No. GTM46402-4019

Part No./Ordering No. WR9QH2100LCPNNAR6B

Rev A

LABEL:L-1186

LABEL P/N: Standard GT
 MATERIAL: Flat Thermal Transfer, Imprintable, Polyester Label and/or Pad Printed and/or Molded, and/or Laser Engraved in the case
 BACKGROUND COLOR: Black if housing is Black, White or Silver if housing is White or Gray.
 TEXT COLOR: White or Silver if label is Black Background for Black housing. Black if label is White or Silver background and Housing is White or Gray
 LABEL WIDTH (mm): 30
 LABEL HEIGHT (mm): 21

Below is the minimum information which will appear on the label. NOTE: in the logo area additional/actual positioning of symbols and text is subjected to change as per agency updates/requirements or additional model approvals become available. Regulatory certifications/label markings may be in logo area on the label or molded into the case housing outside the label area. Information will be shown via label and/or pad printed and/or molded and/or laser engraved in the case. * Date code markings at GlobTek option.



↑
 XXX = USA or CHINA

DATE CODE A *:

DATE CODE LABEL



↑ ↑ ↑
 Series NO. Week Year
 Class NO. for production

or

DATE CODE B *:

WWYY
 WW = WEEK
 YY = YEAR

A=Medical/ITE/Household use Power Supply
 B=P/N: (料号) WR9QH2100LCPNNAR6B
 C=Model (型号) GTM46402-4019
 D=Input (输入) 100-240V~, 50-60 Hz, 1.0A
 E=Output (输出) 19 V 2.1 A ,40.0W

- AGENCY ONLINE DOCUMENTS <http://www.globtek.info/certs/GTM46402/>
- CE EC-Declaration for Medical http://www.globtek.com/pdf/ec_declaration/a00a000000FivPcEAJ
- CE EC-Declaration for Industrial/Commercial/ITE http://www.globtek.com/pdf/ec_declaration/a00a000000FivPcEAJ
- RoHS/RoHS2 Declaration http://www.globtek.com/pdf/rohs_cert/01t0c000008kpkeAAA
- REACH Declaration http://www.globtek.com/pdf/iso_certificates/REACH.pdf

GlobTek, Inc.
www.globtek.com
186 Veterans Drive,
Northvale, NJ 07647
Tel. (201) 784-1000
Fax (201) 784-0111

Drawing Title: GTM46402-4019, Medical/ITE/Household use Power Supply, Efficiency Level: VI, Case Color/Style: GlobTek Black, Wall Plug-in, Regulated Switchmode AC-DC Power Supply AC Adaptor, Input Rating: 100-240V~, 50-60 Hz, Interchangeable Blades <http://en.globtek.com/interchangeable-blades.php>, Output Rating: 40W, 19V@2.1A, Output Configuration: 1200 mm, 16/2 Cond, UL 2468, Female Barrel 5.5 * 2.5 * 11mm with internal Spring Clip and Locking Notch or Equal, Ferrite: None, GlobTek Black, GT Cord # C3039, Pin Out: Center Positive (+V), Blades/Input Cord: Q-Series N. American, Approvals: PSE CB CB cETLus 60950 CB cETLus UL1310 UL SELV CB EAC LPS 2MOPP SG (13.2V) CCC CE Ukraine VCCI RoHS Level VI FCC CAN ICES-3 IP52 Double Insulation WEEE

Model No. GTM46402-4019

Part No./Ordering No. WR9QH2100LCPNNAR6B

Rev A

Conflict Minerals Declaration

<http://www.globtek.com/pdf/conflict-minerals.pdf>

IPXY rating is based on 3rd party testing and customers should check suitability and test system level IPXY rating before ordering.

Regulatory Certifications/Label Markings

LATEST PRODUCT/MODEL CERTIFICATIONS: <http://en.globtek.com/datasheet/id/a00a000000FivPc>

AGENCY ONLINE DOCUMENTS: <http://www.globtek.info/certs/GTM46402/>

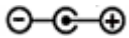

Center Positive (+V)

GlobTek, Inc.
www.globtek.com
186 Veterans Drive,
Northvale, NJ 07647
Tel. (201) 784-1000
Fax (201) 784-0111

Drawing Title: GTM46402-4019, Medical/ITE/Household use Power Supply, Efficiency Level: VI, Case Color/Style: GlobTek Black, Wall Plug-in, Regulated Switchmode AC-DC Power Supply AC Adaptor, Input Rating: 100-240V~, 50-60 Hz, Interchangeable Blades <http://en.globtek.com/interchangeable-blades.php>, Output Rating: 40W, 19V@2.1A, Output Configuration: 1200 mm, 16/2 Cond, UL 2468, Female Barrel 5.5 * 2.5 * 11mm with internal Spring Clip and Locking Notch or Equal, Ferrite: None, GlobTek Black, GT Cord # C3039, Pin Out: Center Positive (+V), Blades/Input Cord: Q-Series N. American, Approvals: PSE CB CB cETLus 60950 CB cETLus UL1310 UL SELV CB EAC LPS 2MOPP SG (13.2V) CCC CE Ukraine VCCI RoHS Level VI FCC CAN ICES-3 IP52 Double Insulation WEEE

Model No. GTM46402-4019

Part No./Ordering No. WR9QH2100LCPNNAR6B

Rev A

PACKAGING

Packing Spec P/N: Standard WPI Q-NA installed,
Individually Box

Box Qty: 60

Gift Box Size (mm): 115*75*90

Gift Box Color: White

Master Carton Size (mm): 440*403*300

Master GW (Kg): 15.2 kg

BLADES INCLUDED: Q-NA(R):

BLADE/CORD INSTALLED: Q-NA(R):

Power Supply & Blade(s) packaged together; see **above "Blades Included"** for actual blades included in the gift box.
If specific packaging is required, this section must specify all requirements and note "no exceptions". If this section does not specify packaging, it is subject to change without notice at GlobTek's discretion

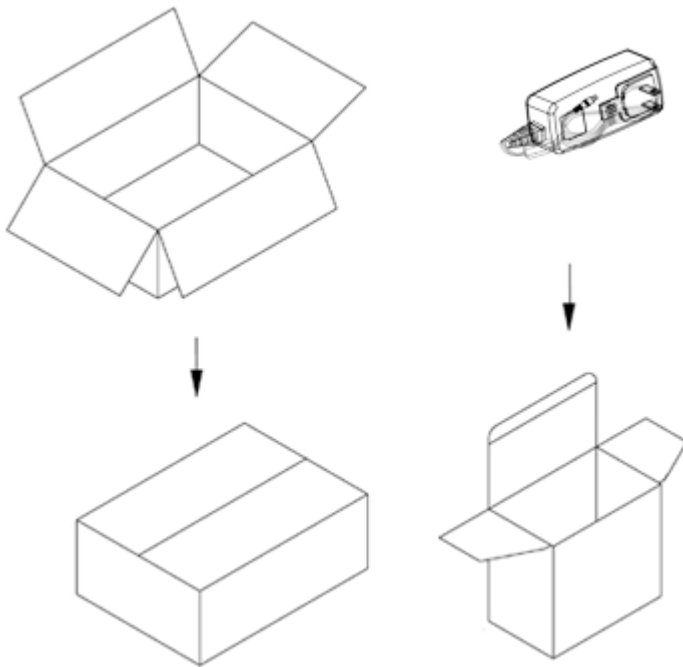

GloTek, Inc. www.globtek.com 186 Veterans Drive, Northvale, NJ 07647 Tel. (201) 784-1000 Fax (201) 784-0111	Drawing Title: GTM46402-4019, Medical/ITE/Household use Power Supply, Efficiency Level: VI, Case Color/Style: GlobTek Black, Wall Plug-in, Regulated Switchmode AC-DC Power Supply AC Adaptor, Input Rating: 100-240V~, 50-60 Hz, Interchangeable Blades http://en.globtek.com/interchangeable-blades.php , Output Rating: 40W, 19V@2.1A, Output Configuration: 1200 mm, 16/2 Cond, UL 2468, Female Barrel 5.5 * 2.5 * 11mm with internal Spring Clip and Locking Notch or Equal, Ferrite: None, GlobTek Black, GT Cord # C3039, Pin Out: Center Positive (+V), Blades/Input Cord: Q-Series N. American, Approvals: PSE CB CB cETLus 60950 CB cETLus UL1310 UL SELV CB EAC LPS 2MOPP SG (13.2V) CCC CE Ukraine VCCI RoHS Level VI FCC CAN ICES-3 IP52 Double Insulation WEEE	
	Model No. GTM46402-4019	
	Part No./Ordering No. WR9QH2100LCPNNAR6B	Rev A

INSTRUCTION SHEET

Q Blades Instruction Sheet (not required to be packaged with product)

Insertion Instructions: <http://www.globtek.com/pdf/Instructions-Interchangeable-Blades.pdf>

This manual is Provided to customer within the product specification - it is the responsibility of

the OEM/customer to provide the end system user instructions + warnings for the use of this product in the end system. By accepting this specification the customer/OEM Agrees to these terms.

USER MANUAL FOR Q-BLADE SERIES SWITCHING POWER SUPPLIES

Manual del Usuario. Fuentes de Alimentación Series Q-Blade

WARNING! RISK OF FIRE! SHOCK HAZARD!: To prevent electric shock, do not remove the cover. No user-serviceable parts inside. This unit contains hazardous voltages and should only be opened by a trained and qualified technician. Do not use if bent, cracked, modified or compromised. To avoid the possibility of electric shock, disconnect electric power to the product before connecting or disconnecting.

Advertencia! Riesgo de Fuego! Peligro de Choque eléctrico!

No contiene dentro componentes servibles para el usuario. Desconecte el cable de alimentación antes de quitar la cubierta.

INDOOR USE ONLY!

Únicamente para uso en el interior.

POWER SUPPLY BLADE/CORD: AC Mains voltage should be provided to the power supply by a power supply cords approved to

the national standards in which it will be used. Please use the below table as a guideline for Suitable Power cords.

CABLE DE ALIMENTACIÓN: El voltaje de la CA debe proporcionarse a la fuente de alimentación mediante

los cables de alimentación aprobados conforme a las normas nacionales según las cuales será utilizada. Utilice por favor la tabla mencionada aquí abajo como guía para los cables eléctricos adecuados.

1. Class II model NEMA 1-15P AC power plug with 2 prongs, Q-NA(R)
2. Australian AS 3112 configuration: SAA 2 pins Class II, Q-SAA(R)
3. UK BS 1363 configuration: UK 2 pins Class II, Q-UKY(R)
4. European CEE 7/16 configuration: Europlug 2 PINS, Class II, Q-EU(R)
5. Korean KS C8305 configuration: Q-KR(R)
6. Argentina IRAM 2073 configuration: 2 pins, Class II Q-AR(R)
7. China GR 2099 configuration: 2 pins, Class II Q-CN(R)
8. India configuration: 2 pins, Class II, Q-IN(R)
9. IEC320/C18 Inlet

FUSING: Internal fuse for Line is provided in the power supply. A blown internal fuse is an indication of catastrophic failure

GlobTek, Inc.
www.globtek.com
186 Veterans Drive,
Northvale, NJ 07647
Tel. (201) 784-1000
Fax (201) 784-0111

Drawing Title: GTM46402-4019, Medical/ITE/Household use Power Supply, Efficiency Level: VI, Case Color/Style: GlobTek Black, Wall Plug-in, Regulated Switchmode AC-DC Power Supply AC Adaptor, Input Rating: 100-240V~, 50-60 Hz, Interchangeable Blades <http://en.globtek.com/interchangeable-blades.php>, Output Rating: 40W, 19V@2.1A, Output Configuration: 1200 mm, 16/2 Cond, UL 2468, Female Barrel 5.5 * 2.5 * 11mm with internal Spring Clip and Locking Notch or Equal, Ferrite: None, GlobTek Black, GT Cord # C3039, Pin Out: Center Positive (+V), Blades/Input Cord: Q-Series N. American, Approvals: PSE CB CB cETLus 60950 CB cETLus UL1310 UL SELV CB EAC LPS 2MOPP SG (13.2V) CCC CE Ukraine VCCI RoHS Level VI FCC CAN ICES-3 IP52 Double Insulation WEEE

Model No. GTM46402-4019

Part No./Ordering No. WR9QH2100LCPNNAR6B

Rev A

of circuit component(s). Repair must be performed by GlobTek, Inc. authorized personnel. Fuses must be replaced with same type and ratings per GlobTek internal documentation.

FUSIBLES: La fuente de alimentación provee un fusible interno para la línea. Un fusible interno quemado es un indicador de una falla catastrófica de los componentes del circuito. La reparación debe ser hecha por personal autorizado de GlobTek, Inc. Los fusibles se deben reemplazar por los mismos tipos y rangos que la documentación interna de GlobTek mencione.

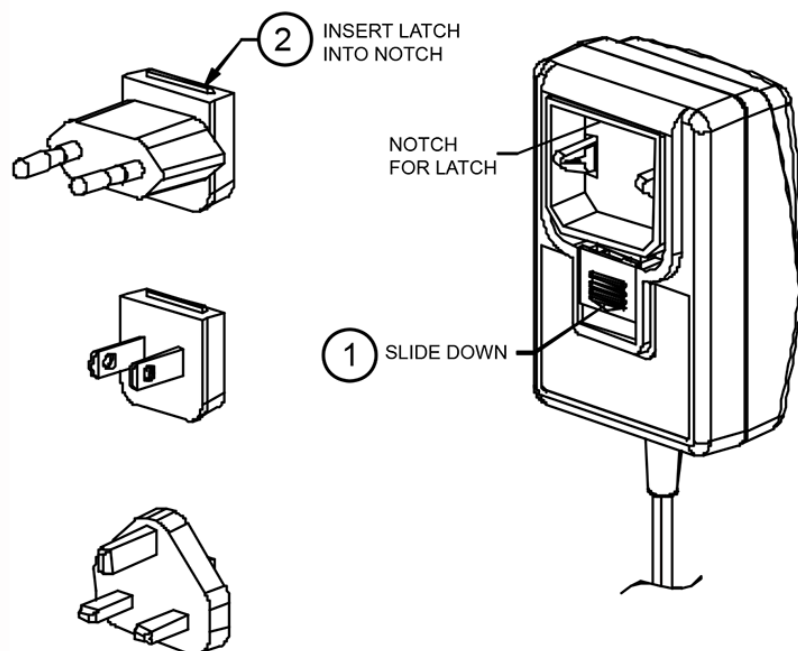

This symbol on an instrument indicates that the user should refer to the operating instructions located in the manual.