

Evaluating the **SSM2380** Audio Amplifier

FEATURES

Accepts either differential or single-ended inputs
Full featured evaluation board for the **SSM2380**
PCB footprint for optional EMI filter
Includes USB hardware interface for plug-and-play operation
Microsoft Windows®-based evaluation software with simple graphical user interface

EQUIPMENT NEEDED

Audio source with $\frac{1}{8}$ " male stereo plug or 0.100" header
Power supply (5.0 V, 2.0 A recommended)
EVAL-SSM2380Z evaluation board
PC running Windows XP or later; USB 2.0 port required
Stereo speakers or other load

DOCUMENTS NEEDED

SSM2380 data sheet

SOFTWARE NEEDED

SSM2380 evaluation software

GENERAL DESCRIPTION

The **SSM2380** evaluation board is a complete solution for driving two loudspeakers. It includes the **SSM2380** amplifier IC and the additional components needed to connect the I²C bus to a personal computer using a universal serial bus (USB) connection. Figure 1 shows the evaluation board in a simple configuration with USB and power and audio input connections.

The **SSM2380** features an I²C interface with many useful settings. Using the I²C control interface, the gain of the **SSM2380** can be selected from any of 47 values between 1 dB and 24 dB. Other features available when using the I²C interface include independent left/right channel shutdown, EMI emission control modes, automatic level control (ALC), and stereo-to-mono input mixing.

This user guide describes how to use the **EVAL-SSM2380Z** to test the features of the **SSM2380** stereo amplifier. It describes the hardware and software of the **SSM2380** evaluation board, including detailed schematics and PCB layout artwork.

The **SSM2380** data sheet, available at www.analog.com/SSM2380, provides detailed information about the specifications, internal block diagrams, and application guidance for the amplifier IC.

The **SSM2380** evaluation software can be downloaded from www.analog.com/SSM2380. Click **Evaluation Boards & Kits** and choose the appropriate Windows version (32-bit or 64-bit).

TYPICAL I²C INTERFACE CONFIGURATION

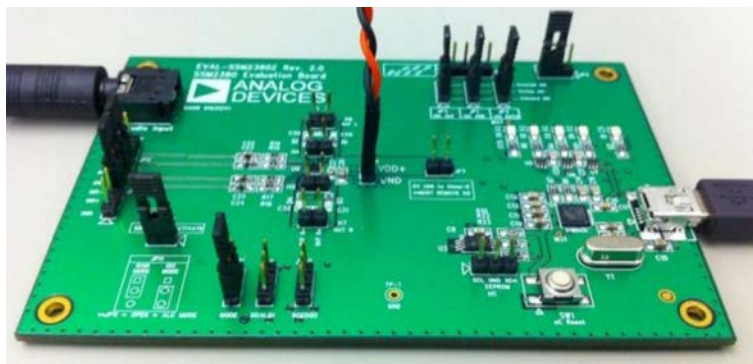

Figure 1. **EVAL-SSM2380Z** Evaluation Board

TABLE OF CONTENTS

Features	1	Initial SSM2380 Hardware Setup	6
Equipment Needed	1	SSM2380 GUI Functional Blocks	8
Documents Needed	1	Input Control	8
Software Needed	1	Output Control	8
General Description	1	Auxiliary Functions	9
Typical I ² C Interface Configuration	1	Quick Set Buttons	10
Revision History	2	Direct I ² C Register Access	10
Evaluation Board Hardware	3	USB Power	10
Power Supplies	3	USB—I ² C Interface	11
Input Signals	3	General Description	11
Output Signals	3	USB Connector	11
Shutdown and Mode Jumpers	3	Power Regulator	11
LEDs	4	Cypress USB Interface	11
EEPROM	4	Crystal Oscillator	11
USB Power Switch	4	Passive Component Selection	12
I ² C Source Jumpers	4	Input Coupling Capacitor Selection (C22 to C25)	12
Operating Modes	5	Output Ferrite Beads (B1 to B4)	13
I ² C Control Mode	5	Output Shunting Capacitors (C29 to C32)	13
ALC Mode	5	Output Inductors (L1 to L4)	13
Gain Select Mode	5	Evaluation Board Schematics and Artwork	14
Evaluation Board Software Quick Start Procedures	6	Ordering Information	18
SSM2380 Control Software Setup	6	Bill of Materials	18

REVISION HISTORY

9/11—Revision 0: Initial Version

EVALUATION BOARD HARDWARE

The [SSM2380](#) evaluation board provides all of the support circuitry required to operate the [SSM2380](#) amplifier, including a computer interface for the I²C bus. Figure 2 shows the typical bench characterization setup used to evaluate the audio performance of the [SSM2380](#). See the Evaluation Board Software Quick Start Procedures section to get started.

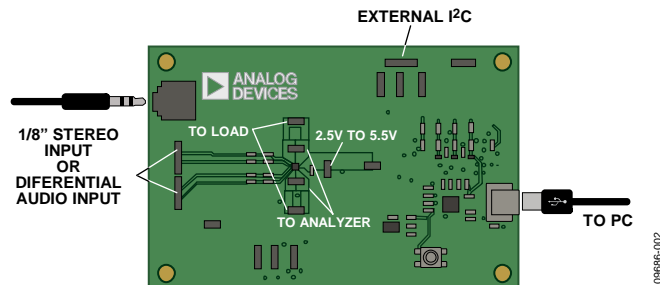

Figure 2. Diagram View of Evaluation Board Connections

POWER SUPPLIES

The [SSM2380](#) requires an external dc power supply. A 2-pin 0.100" male header, H3, is provided on the evaluation board. Supply voltages between 2.5 V and 5.5 V are accepted, and supply currents may exceed 1 A under some conditions.

Alternatively, 5 V USB power supply can be used to power the chip, although the USB 2.0 specification only allows current draw up to 500 mA. Be cautious when using the USB port to supply any significant amount of power. The jumper configuration used for USB power is shown in Figure 3.

Be sure to remove JP7 when using an external power supply, as this will short the I²C voltage to the external supply. Conversely, be sure to remove the external supply from H3 when using USB power.



Figure 3. Connecting USB Power Supply to [SSM2380](#)

INPUT SIGNALS

On the left side of the PCB are two 4-pin headers, JP5 and JP6. These are used to connect the input audio signal to the amplifier. If the input audio signal is differential, use the two center pins of JP5 (INL+ and INL-) for left channel audio and the two center pins of JP6 (INR+ and INR-) for the right channel audio. In this case, connect either the top or the bottom pin to the source/signal ground.

For single-ended audio inputs, only two pins of JP5 and two pins of JP6 are used: ground and the input signal. If a non-inverting input is desired, connect the input signals to INL+ and INR+, and place jumpers between Pin 3 and Pin 4 of JP5 and JP6, shorting INL- and INR- to ground.

Conversely, if an inverting input is desired, connect the input signals to INL- and INR-, and place the jumpers between Pin 1 and Pin 2 of JP5 and JP6, shorting INL+ and INR+ to ground.

Alternatively, single-ended stereo audio can be supplied by connecting a standard 1/8" stereo plug to the J2 input. In this case, jumpers must connect INL- and INR- to ground.

OUTPUT SIGNALS

Each channel of the amplifier output is available at two 2-pin 0.100" headers. The speakers are connected in bridge-tied load (BTL) configuration, and the output pins are labeled with their polarity; for example, OUTL+ indicates the left channel noninverting terminal.

In the standard filterless configuration, the two headers on each channel are connected with 0 Ω links on the pads marked B1 to B4. In this case, the two headers on each channel are tied together and can be used interchangeably as attachment points for the load and an audio analyzer. The EMI filtering is not populated on the [SSM2380](#) evaluation board to allow proper measurement of key parameters such as SNR and THD.

The top layer of the PCB contains the footprints necessary for a ferrite bead-based EMI filter configuration, whereas the bottom layer of the PCB contains the footprints for an inductor-based EMI filter. If EMI filtering is used, only H6 and H7 connect at the proper location with respect to the filter components—the load must be connected to these headers. Measurements of the unfiltered waveform can be taken at H4 and H5.

SHUTDOWN AND MODE JUMPERS

The 2-pin jumper, JP8, is used to enable and disable the [SSM2380](#) amplifier. Inserting a jumper across JP8 pulls the \overline{SD} pin to the SPKVDD supply rail, activating the amplifier. Removing the jumper from JP8 shuts down both channels of the [SSM2380](#) so that minimal current (about 20 nA) is drawn from the power supply.

LEDS

The LEDs provide feedback to the user about the status of the Cypress USB microcontroller. The function of each LED is shown in Table 1.

Table 1. LED Functions

Reference Designator	Color	Function
D1	Red	5V power is supplied over the USB bus
D2	Yellow	I ² C mode is active
D3	Blue	GPIO LED, for firmware debug purposes
D4	Yellow	SPI mode is active
D5	Blue	USB power switch enabled (USB_PWR_ON)

EEPROM

The USBi has an EEPROM on the I²C bus at Address 0x51, which it uses to indicate its vendor ID and product ID to the PC, as well as boot its internal program. The EEPROM is an important system element that identifies the board to the host PC and stores the firmware for the Cypress USB interface. The EEPROM is programmed during manufacturing via the H1 connector.

Avoid having any other EEPROMs in your system design at this address. This EEPROM is not write-protected; therefore, an attempt to write to Address 0x51 overwrites the USBi's on-board EEPROM, and the USBi will cease to function. The USBi cannot be reprogrammed without returning it to Analog Devices.

USB POWER SWITCH

The *SSM2380* evaluation board is capable of taking 5 V power from the USB port after the Cypress USB microcontroller has finished its boot up process. The USB_PWR_ON signal, which can be set in the *SSM2380* software, appears on one pin of the Cypress microcontroller. This signal controls, Q1 and Q2, create a connection between USB power and the supply rail. D5, a blue LED, lights up when this supply is activated. Note that the current available from the USB bus is limited; therefore, the amplifier power stage may not drive low impedance loads properly.

I²C SOURCE JUMPERS

If an external I²C source is to be used, place the JP1, JP2, and JP3 jumpers such that they connect the device I²C lines to the external I²C lines. Otherwise, they should connect the device I²C lines to the on-board I²C lines, as shown in the red rectangular area of Figure 4. If an external I²C is used, an external I²C source can be attached to H2, following the silkscreen labels displayed on the board.

The voltage of the external I²C interface should match the value set on JP4; the two voltages are taken from two separate on-board regulators. The on-board I²C interface works properly in either configuration.

For the Cypress USB microcontroller to boot properly from the EEPROM, it may be necessary to power down (or disconnect) any other devices from the I²C bus, including the *SSM2380*. In this case, remove the external 5 V supply while the USB connection is first established, or remove the JP2 and JP3 jumpers and replace them only after the connection is activated.

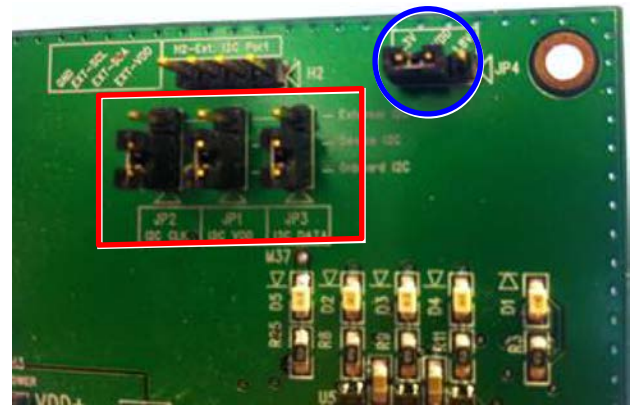

Figure 4. Jumpers as Configured for On-Board I²C Operation

OPERATING MODES

The **SSM2380** has three operating modes: I²C control mode, ALC mode, and gain select mode. These modes are described in detail in the **SSM2380** data sheet. On the evaluation board, the 3-pin JP11 jumper allows the user to change between the available operating modes.

I²C CONTROL MODE

To operate the **SSM2380** in I²C control mode, connect JP11 as shown in Figure 5, connecting the MODE pin to GND. While in I²C control mode, JP9 and JP10 are not used and the jumpers should be left unconnected.

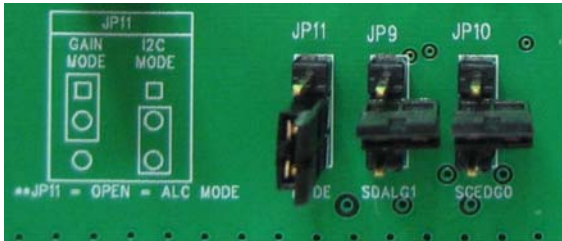

Figure 5. Jumper Connections for I²C Mode Operation

ALC MODE

The proper connections for ALC mode are shown in Figure 6. For this setting, JP11 is open and the middle and bottom pins of JP9 are shorted. This floats the MODE pin and makes a connection from the **SSM2380** ALCTH pin with Resistor R24 to GND, setting the **SSM2380** ALC limiting range. JP10 is used to activate the radiated emissions reduction mode in this configuration.

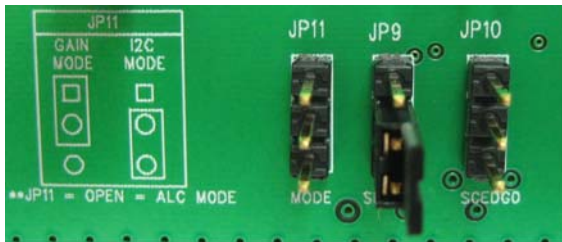

Figure 6. Jumper Connections for ALC Mode Operation

The limiting percentage of the ALC feature is determined by the value of an external resistor, R24, which should be placed on the secondary side of the board. The resistor value can be calculated using the curve shown in Figure 7.

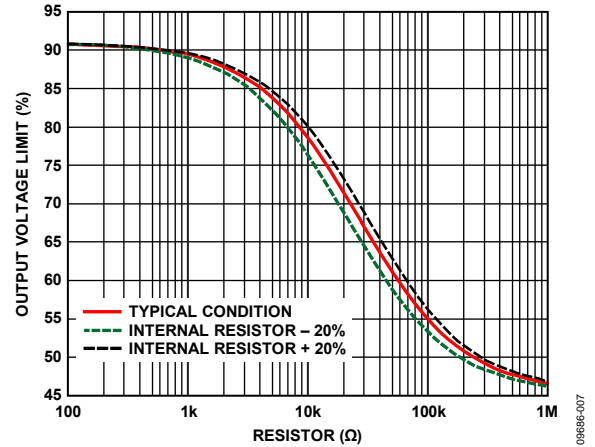

Figure 7. Output Voltage Limit (V_{TH}) vs. R_{TH}

GAIN SELECT MODE

The proper connections for gain select mode are shown in Figure 8. A jumper must be inserted on JP11 from center pin to top pin. JP9 and JP10 allow the user to select the **SSM2380** gain from 6 dB to 24 dB. To connect the appropriate gain select pin to VDD, place a jumper from the center pin to the top pin of the header. To select GND, simply move the jumper connection to the center pin and bottom pin of the header. A gain select table shows all possible settings in Table 2. All other features (ALC, emissions control, and mixer) are deactivated while the **SSM2380** is in gain select mode.

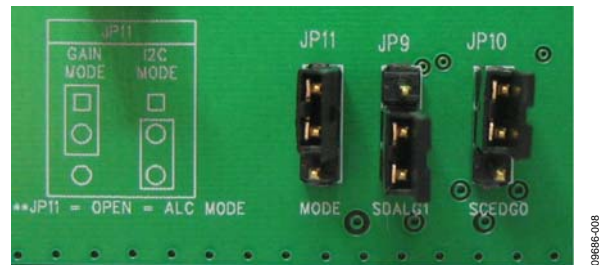

Figure 8. Jumper Connections for Gain Select Mode Operation

Table 2. Gain Select Mode Settings for JP9 and JP10

GAIN1 (JP9)	GAIN0 (JP10)	Gain Setting
GND	GND	6 dB
GND	VDD	12 dB
VDD	GND	18 dB
VDD	VDD	24 dB

EVALUATION BOARD SOFTWARE QUICK START PROCEDURES

SSM2380 CONTROL SOFTWARE SETUP

Do not connect the evaluation board until software is installed. The **SSM2380** software interface requires Microsoft® .NET Framework (Version 2.0 or later). The installer automatically downloads it if .NET Version 2.0 is not already installed.

To install the control software, use the following steps:

1. Go to www.analog.com/SSM2380.
2. Click **Evaluation Boards & Kits**.
3. Choose the appropriate Windows version (32-bit or 64-bit) to download.
4. Extract the **SSM2380** zipped installation file to a convenient location and double-click **setup.exe** to begin the installation process. Follow the installation instructions when prompted.
5. The software and USB drivers are installed in **C:\Program Files\Analog Devices Inc\SSM2380**.

SSM2380 USB Driver Installation

Before connecting the **SSM2380** evaluation board to a PC or notebook, the following procedure may need to be completed. (This procedure only needs to be executed once on each computer that uses the **SSM2380** software. This procedure can be skipped if the user has previously installed any SigmaStudio or USBi related drivers from Analog Devices, Inc.)

1. Exit the **SSM2380** user interface software.
2. Remove jumpers from JP1, JP2, and JP3, located at the top of the evaluation board to completely isolate the Cypress USB driver from the **SSM2380**.
3. Connect JP4 in the 3.3 V location as shown in the blue-circled area of Figure 4. The purpose of this is to power the Cypress USB controller to establish communication between the software and the board.
4. Make sure the software was closed. Connect the **SSM2380** evaluation board to the PC via the USB cable.
5. The PC recognizes the new hardware. When the hardware is recognized, a prompt asks to let Windows find the proper drivers for the hardware. Do not let Windows install the drivers.
6. The user must direct the driver installation to the following path by clicking the **Browse** tab:
C:\Program Files\Analog Devices Inc\SSM2380
7. After the path has been properly selected, the user can continue with the driver installation process. Windows will properly establish the link between the Cypress USB controller and the PC.

8. After the previous steps are followed, the user can now run the **SSM2380** control software. The software is located at the following path: **C:\Program Files\Analog Devices Inc\SSM2380\SSM2380.exe**.
9. For quick access to this software, the installer creates a shortcut from the **SSM2380.exe** file to the desktop.
10. If all steps were properly followed, at the top of the **SSM2380** software window, a status message of **USBi Connected** appears. If the installation was not successful, a message of **USBi – Cannot Find Device** appears.
11. After a successful installation, the **SSM2380** software recognizes a connection from the PC to the **SSM2380** evaluation board. There is no need to adjust the jumper positions of JP1, JP2, and JP3; but they should be connected as shown in Figure 4.

Uninstall SSM2380 Control Software

1. Locate the directory where the **SSM2380** zipped installer file was extracted.
2. Double-click **setup.exe**. Simply select **Uninstall** to remove the software from the host PC.

INITIAL SSM2380 HARDWARE SETUP

To allow the **SSM2380** software to control the **SSM2380** evaluation board, the user must make a few simple jumper connections:

1. Connect the bottom and middle terminals of each jumper JP1, JP2, and JP3. The purpose of this is to connect the on-board Cypress USB-I²C interface to the **SSM2380**. The signals connected are I²C VDD, I²C CLK, and I²C DATA.
2. Connect JP4 in one of two positions to choose an I²C supply rail, either 1.8 V or 3.3 V. These two voltages come from separate on-board LDOs. The **SSM2380** control interface works well under either of these I²C supply voltage conditions.

The screenshot displays the SSM2380 Evaluation Software v1.0 interface, titled "USBi - Connected". The interface is organized into several functional panels:

- Input Control:**
 - Left Gain Control (Register R0):** Includes a "Mute" checkbox, "Left-To-Right Gain" checkbox, and a "Gain Selection" dropdown menu set to "100010 = 18dB (default)".
 - Right Gain Control (Register R1):** Includes a "Mute" checkbox, "Right-To-Left Gain" checkbox, and a "Gain Selection" dropdown menu set to "100010 = 18dB (default)".
- Output Control:**
 - ALC Control 1 (Register R3):** Features "Recovery Time" (101 = 128ms / step) and "Attack Time" (011 = 256us / step) dropdown menus.
 - ALC Control 2 (Register R4):** Includes an "ALC Enable" checkbox, "Compressor Settings" (10 = Compression 2), "Threshold Mode" (Fixed Power or Supply Tracking), and "Threshold Settings" (1011 = 90.3% / 3.89).
- Auxiliary Functions:**
 - Shutdown (Register R5):** Controls for "Left Channel" and "Right Channel", each with "ON" and "OFF" radio buttons.
 - Mode Control (Register R2):** Includes checkboxes for "Overcurrent Autorecovery" and "Overtemperature Autorecovery", and "R-to-L Signal Mix" and "L-to-R Signal Mix" checkboxes.
 - Edge Speed:** A dropdown menu set to "00 = normal (default)".
 - Error (Register R6):** Includes checkboxes for "Overcurrent right", "Overtemp warning", "Overcurrent left", and "Overtemp error".
- USB Power:** A panel with two radio buttons: "5V USB Power ON" (selected) and "5V USB Power OFF".
- Quick Set Operation:** A panel with three buttons: "RESET" (red), "Music Optimized", and "Voice Optimized".
- Register Controls:** A vertical column of controls for registers R0 through R8, each with "Read" and "Write" buttons and a text input field.
- Bottom Panel:** Includes the "ANALOG DEVICES" logo, the text "SSM2380 Evaluation Software v1.0", and two buttons: "Read All Registers" and "Clear Register Text".

Figure 9. SSM2380 Evaluation Software

SSM2380 GUI FUNCTIONAL BLOCKS

The **SSM2380** control software is logically split into several different functional blocks. Each functional block is split into the individual subsections.

Note that when the power supply of the **SSM2380** is interrupted, you must reset the **SSM2380** software to synchronize with the device. Simply click the red **RESET** button at the bottom-left corner of the software window (see Figure 9).

INPUT CONTROL

This section controls the left and right gain control operation of **SSM2380**.

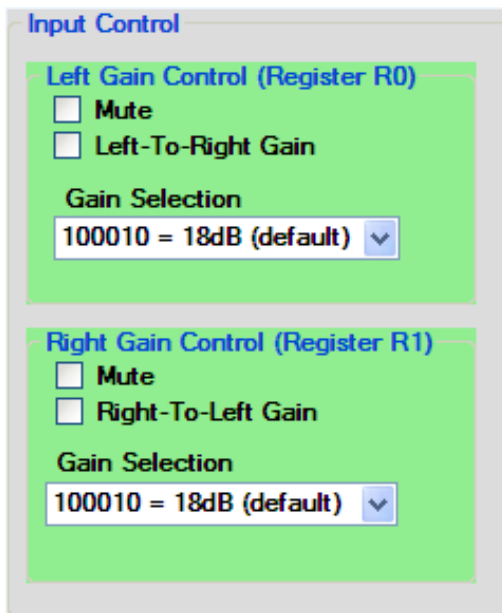

Figure 10. Input Control Section of **SSM2380** GUI

Left Gain Control (Register R0)

This is associated with Control Register R0. Options include mute, left-to-right gain loading (load left gain to right channel), and left channel gain. The left channel gain can be set from 1 dB to 24 dB in 0.5 dB increments.

Right Gain Control (Register R1)

This is associated with Control Register R1. Options include mute, right-to-left gain loading (load right gain to left channel), and right channel gain. The right channel gain can be set from 1 dB to 24 dB in 0.5 dB increments.

OUTPUT CONTROL

This section controls the auto level control (ALC) of the **SSM2380**.

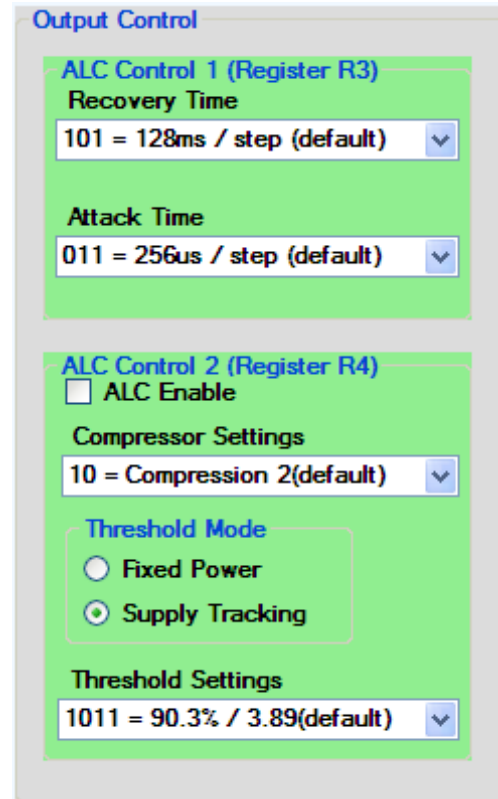

Figure 11. Output Control Section of **SSM2380** GUI

ALC Control 1 (Register R3)

This is associated with Control Register R3. This section allows the user to control the release time and attack time of the **SSM2380**.

ALC Control 2 (Register R4)

This is associated with Control Register R4. This section allows the user to enable ALC operation, to set the compressor operation mode (light to heavy compression and limiting), to set the limiter level, and to set the limiter mode.

There are two limiter modes: fixed power and supply tracking. Fixed power mode sets the output limiter level to a fixed value, independent of the power supply rail. Supply tracking mode sets the limiter as a percentage of SPKVDD.

Note that if the user intends to change the gain setting registers, R0 or R1, the user must toggle the **ALC Enable** check box to allow the new gain settings to take effect.

AUXILIARY FUNCTIONS

This section allows user access to the power management control registers, current/thermal fault recovery, mixing operation, and edge rate control.

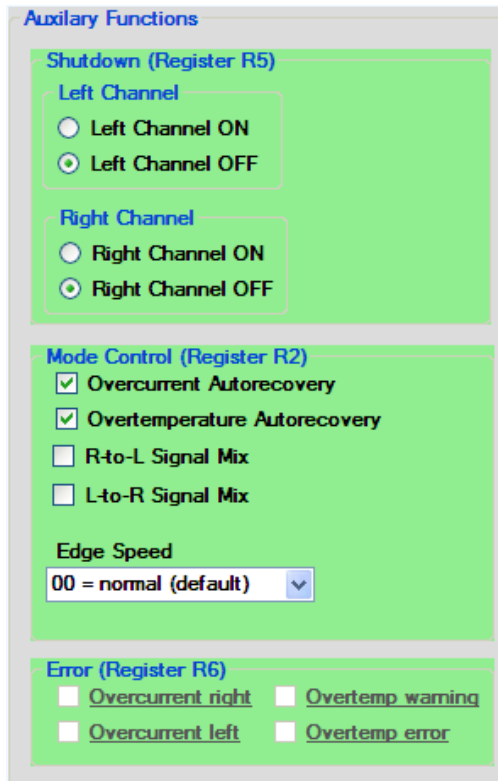

Figure 12. Auxiliary Function Section of SSM2380 GUI

Shutdown (Register R5)

To enable the SSM2380, simply click **ON** for left and/or right channels.

Mode Control (Register R2)

The **Mode Control (Register R2)** section, which is associated with Control Register R2, contains a collection of unrelated settings, including current and thermal fault recovery, mixers, and emissions control modes.

Current/Thermal Fault Recovery

The **Overcurrent Autorecovery** and **Overtemperature Autorecovery** check boxes control the autorecovery feature of the fault detection mode. When selected, the autorecovery feature is active. When cleared, the device stays in fault protection mode until the reset register, R8, is written to zero or the device loses power.

Mixer Modes

When **R-to-L Signal Mix** is selected, the right input signal is mixed to both right and left outputs. When **L-to-R Signal Mix** is selected, the left input signal is mixed to both left and right outputs.

Edge Speed

Several different emission control mode levels can be set. The slowest setting yields the best emission suppression, but it may degrade SNR and efficiency measurements slightly.

Error (Register R6)

This section is associated with Control Register R6. Each block is a read-only indicator that is activated when a particular fault condition is encountered. It does not update unless the R6 **Read** button is clicked, as detailed in the Direct I²C Register Access section. This feature is only active if the fault recovery options (overcurrent autorecovery and overtemperature autorecovery) are enabled.

QUICK SET BUTTONS

The GUI includes a collection of buttons to switch quickly to several predefined configurations. See Figure 13 and the following three sections for details.



Figure 13. Preset Button Section of SSM2380 GUI

RESET

RESET first initializes the SSM2380 by writing all 0s to Control Register R8. It then clears all previously stored read/write windows and ensures that all registers are set to the proper default value. The RESET button should be clicked every time power is disrupted from the SSM2380 to synchronize the SSM2380 to the control software.

Music Optimized

By clicking the Music Optimized preset button, the following occurs:

- Left and right channels are enabled.
- Gain for both left and right channels is set to 18 dB.
- The ALC operation is enabled and tuned for optimized sound quality for music playback. A slower attack time is used, along with heavier compression and a slower release time.

Voice Optimized

By clicking the Voice Optimized preset button, the following occurs:

- Left and right channels are enabled.
- Gain for both left and right channels is set to 18 dB.
- The ALC operation is enabled and tuned for optimized SPL level for voice playback. A faster attack time is used, a small amount of compression before limiter operation, and a faster release time.

DIRECT I²C REGISTER ACCESS

Within each subsection is direct access to the associated I²C control register. If the user desires, data can be directly written to the control register by typing the register data byte in hexadecimal format. Simply type the desired word in hexadecimal format in the desired register write window. Click the Write button when ready to send this data to the SSM2380. The associated subsection options from the main GUI section are also updated. You can also check the register contents by clicking the Read button. The register contents are displayed in the text box next to each button.

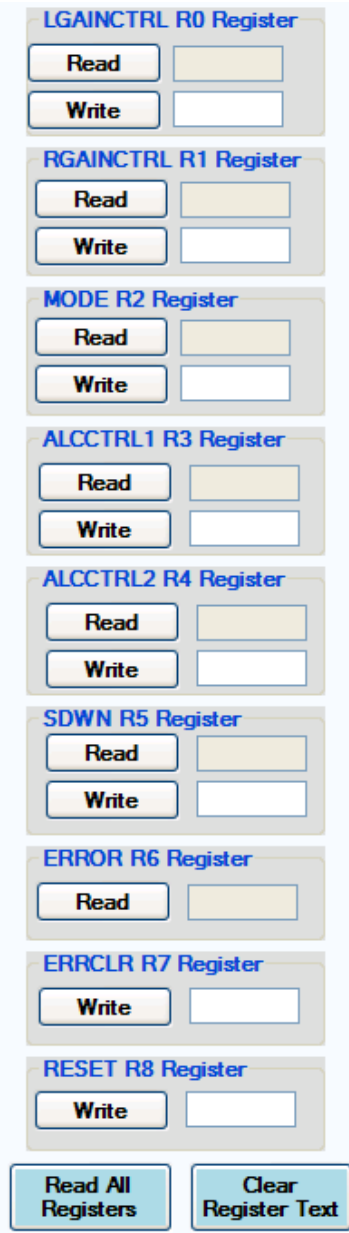

Figure 14. I²C Register Direct Control of SSM2380 GUI

USB POWER

The 5 V power switch, described in the USB Power Switch section, is activated by clicking 5V USB Power ON as shown in Figure 15.



Figure 15. USB Power Control

USB—I²C INTERFACE

GENERAL DESCRIPTION

The EVAL-ADUSB2EBZ, also known as the USBi, is a standalone communications interface adapter and programmer used in the evaluation of SigmaDSP® systems. It translates USB control commands from SigmaStudio to the I²C and SPI communications protocols.

To simplify bench evaluation, an interface based on the USBi adapter is included on the [SSM2380](#) evaluation board. This eliminates the need for a separate interface board and 10-pin ribbon cable; only a USB mini-B cable is required. This interface is shown in Figure 16.

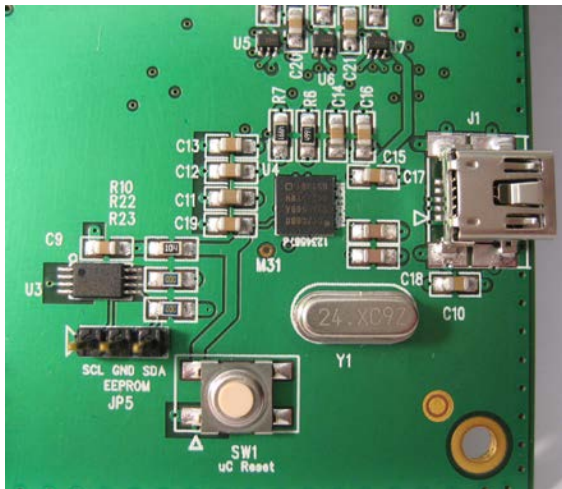

Figure 16. USB to I²C Microcontroller and USB interface

The on-board regulators enable both 1.8 V and 3.3 V IOVDD operation, allowing for increased testing flexibility.

The USBi interface can also control SigmaDSP systems in real time via SigmaStudio, and it is capable of programming an EEPROM in self-boot systems. It is an ideal solution for in-circuit programming and tuning of prototype systems.

The USBi only supports USB 2.0 interfaces; it does not work with PCs that only support USB Version 1.0 and USB Version 1.1.

USB CONNECTOR

The connection between the host PC and the Cypress USB interface device is via a standard USB cable that carries D+ and D– signals for data communications, a 5 V power supply, and ground. The D+ and D– lines are a 1-wire communication interface carried by half-duplex differential signals on a twisted pair. The clock is embedded in the data using the nonreturn-to-zero inverted (NRZI) line code. These signal lines connect directly to pins on the Cypress USB interface.

A surface-mounted USB miniature Type B jack was selected for its low profile and increasing popularity in consumer electronics.

POWER REGULATOR

The Cypress USB interface I/O ports are capable of operating in both 1.8 V and 3.3 V modes, depending on the target device in the system. Two regulators, one for 5 V to 3.3 V regulation and the other for 5 V to 1.8 V regulation, run simultaneously when the board is powered. A jumper (JP4) is provided to easily switch the IOVDD supply between the two regulators. D1 provides visual feedback that the board is being supplied with 5 V power from the PC USB port.

The position of Jumper JP4 should not be changed when the board is connected to the USB bus.

CYPRESS USB INTERFACE

The Cypress USB interface is the core of the system, including all of the necessary functionality to convert USB commands into corresponding I²C or SPI read/write transfers, and acts as a FIFO to route data between the host PC and the target device.

CRYSTAL OSCILLATOR

The Cypress USB interface is its own clock master, and the board includes a crystal oscillator circuit with a 24 MHz crystal resonator to provide stability to the oscillator circuit. The crystal resonator is driven by the XTALOUT and XTALIN pins of the Cypress USB interface.

PASSIVE COMPONENT SELECTION

Although the evaluation board is preloaded with the passive components required for a basic configuration, the user may wish to evaluate the same circuit with different component values or filter designs. Selecting the proper components is the key to achieving the performance required at the budgeted cost.

INPUT COUPLING CAPACITOR SELECTION (C22 TO C25)

The input coupling capacitors, C22 to C25, should be large enough to couple the low frequency signal components in the incoming signal and small enough to filter out unnecessary low frequency signals. For music signals, the cutoff frequency chosen is often between 20 Hz and 30 Hz to preserve the low frequency components of the signal; for applications with small speakers, a higher cutoff frequency is often chosen to reduce the power wasted on audio that cannot be reproduced by the speaker.

The value of each input capacitor is calculated by

$$C = 1/(2\pi R_{IN}f_C)$$

where:

R_{IN} is the amplifier's input resistance.

f_C is the cutoff frequency.

Because R_{IN} varies with amplifier gain value from 7.3 k Ω to 55 k Ω over the entire gain range of the [SSM2380](#), this calculation must be performed carefully to ensure that the low frequency performance is acceptable at all gain levels. The relationship between gain and input resistance is shown in Table 3.

As an example calculation, suppose that the low frequency cutoff is to be no higher than 200 Hz and that the amplifier gain varies between 6 dB and 18 dB. In this case, the input resistance is between 39.6 k Ω and 13.6 k Ω . Because the cutoff frequency is highest when the input resistance is small, the calculation should be done using the minimum value—in this case, giving a minimum capacitance of approximately 59 nF. A larger standard value (perhaps 100 nF) should be used to account for the ordinary variation due to tolerance, temperature coefficient, and so on.

Table 3. Input Impedance for I²C Control Mode

LGAIN[5:0], RGAIN[5:0]	Gain (dB)	R _{IN} (k Ω)
101110	24.0	7.3
101101	23.5	7.7
101100	23.0	8.1
101011	22.5	8.5
101010	22.0	9.0
101001	21.5	9.5
101000	21.0	10.0
100111	20.5	10.5
100110	20.0	11.1
100101	19.5	11.7
100100	19.0	12.3
100011	18.5	12.9
100010	18.0	13.6
100001	17.5	14.3
100000	17.0	15.0
011111	16.5	15.8
011110	16.0	16.6
011101	15.5	17.4
011100	15.0	18.3
011011	14.5	19.2
011010	14.0	20.1
011001	13.5	21.1
011000	13.0	22.1
010111	12.5	23.1
010110	12.0	24.2
010101	11.5	25.3
010100	11.0	26.4
010011	10.5	27.6
010010	10.0	28.8
010001	9.5	30.0
010000	9.0	31.3
001111	8.5	32.6
001110	8.0	34.0
001101	7.5	35.3
001100	7.0	36.7
001011	6.5	38.1
001010	6.0	39.6
001001	5.5	41.1
001000	5.0	42.6
000111	4.5	44.1
000110	4.0	45.6
000101	3.5	47.1
000100	3.0	48.7

OUTPUT FERRITE BEADS (B1 TO B4)

The output beads, B1 to B4, are suggested components for filtering out the EMI caused at the switching output nodes. The penalty for using ferrite beads for EMI filtering is slightly worse noise and distortion performance at the system level due to the nonlinearity of the beads. Ensure that these beads have enough current conducting capability while providing sufficient EMI attenuation. The current rating needed for an 8 Ω load is approximately 420 mA, and impedance at 100 MHz must be $\geq 120 \Omega$. In addition, the lower the dc resistance (DCR) of these beads, the better for minimizing their power consumption. Table 4 describes suggested beads.

OUTPUT SHUNTING CAPACITORS (C29 TO C32)

There are four output shunting capacitors, C29 to C32, that work with the B1 to B4 ferrite beads or with the L1 to L4 inductors, if they are used. Use small size (0603 or 0402),

multilayer ceramic capacitors that are made of X7R or C0G (NP0) materials. Note that the capacitors can be used in pairs: a capacitor with small capacitance (up to 100 pF) plus a capacitor with a larger capacitance (less than 1 nF). This configuration provides thorough EMI reduction for the entire frequency spectrum. Alternatively, a single capacitor of approximately 470 pF can be used if BOM reduction is a priority.

OUTPUT INDUCTORS (L1 TO L4)

If inductors are preferred for EMI filtering at the output nodes, choose a component value less than 2.2 μH for these inductors. The higher the inductance, the lower the EMI is at the output; however, the cost and power consumption by the inductors are higher. Using 0.47 μH to 2.2 μH inductors is recommended, and the saturation current rating must be larger than 600 mA for an 8 Ω load. Table 5 shows suggested inductors.

Table 4. Suggested Output Beads

Part No.	Manufacturer	Z (Ω)	I _{MAX} (mA)	DCR (Ω)	Size (mm)
BLM18PG121SN1D	Murata	120	2000	0.05	1.6 × 0.8 × 0.8
MPZ1608S101A	TDK	100	3000	0.03	1.6 × 0.8 × 0.8
MPZ1608S221A	TDK	220	2000	0.05	1.6 × 0.8 × 0.8
BLM18EG221SN1D	Murata	220	2000	0.05	1.6 × 0.8 × 0.8

Table 5. Suggested Output Inductors

Part No.	Manufacturer	L (μH)	I _{MAX} (mA)	DCR (Ω)	Size (mm)
LQM31PNR47M00	Murata	0.47	1400	0.07	3.2 × 1.6 × 0.85
LQM31PN1R0M00	Murata	1.0	1200	0.12	3.2 × 1.6 × 0.85
LQM21PNR47MC0	Murata	0.47	1100	0.12	2.0 × 1.25 × 0.5
LQM21PN1R0MC0	Murata	1.0	800	0.19	2.0 × 1.25 × 0.5
LQH32CN2R2M53	Murata	2.2	790	0.1	3.2 × 2.5 × 1.55
LBC2518T2R2M	Taiyo Yuden	2.2	630	0.13	2.5 × 1.8 × 2
1033AS-4R7M	Toko	4.7	680	0.31	3.8 × 3.8 × 1

EVALUATION BOARD SCHEMATICS AND ARTWORK

610-98960

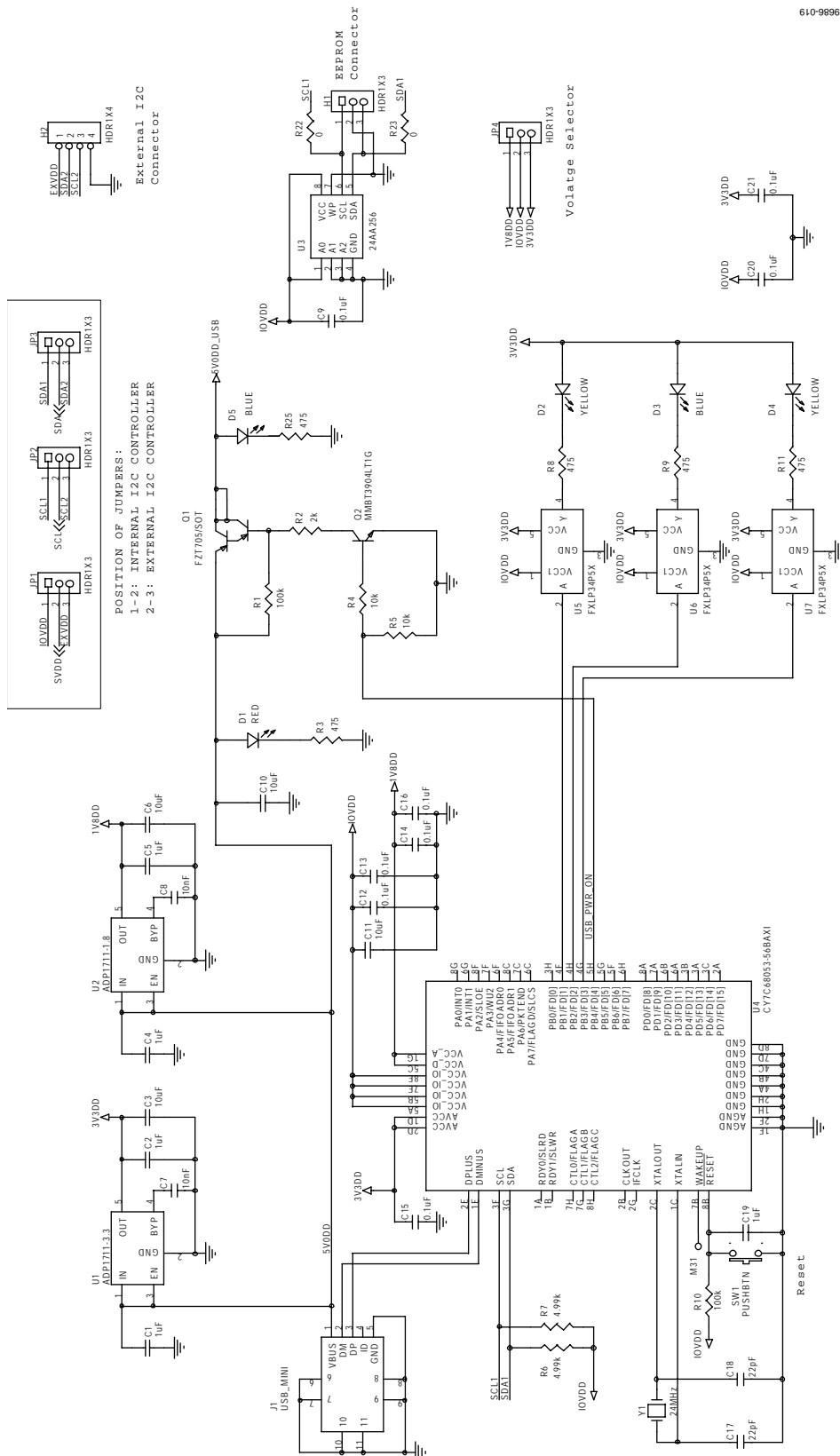

Figure 17. USB Interface Schematic

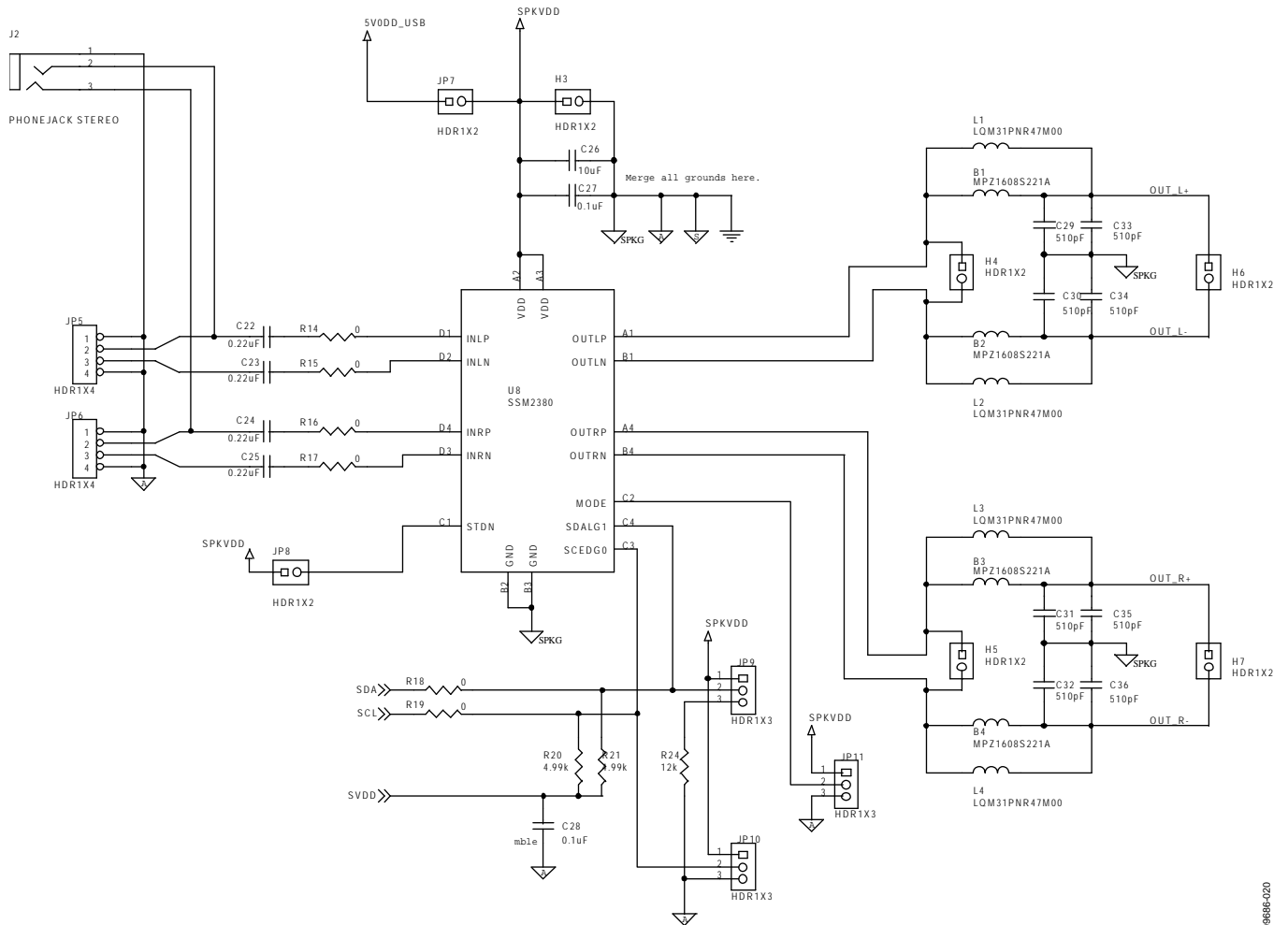

Figure 18. SSM2380 Schematic

09H86-020

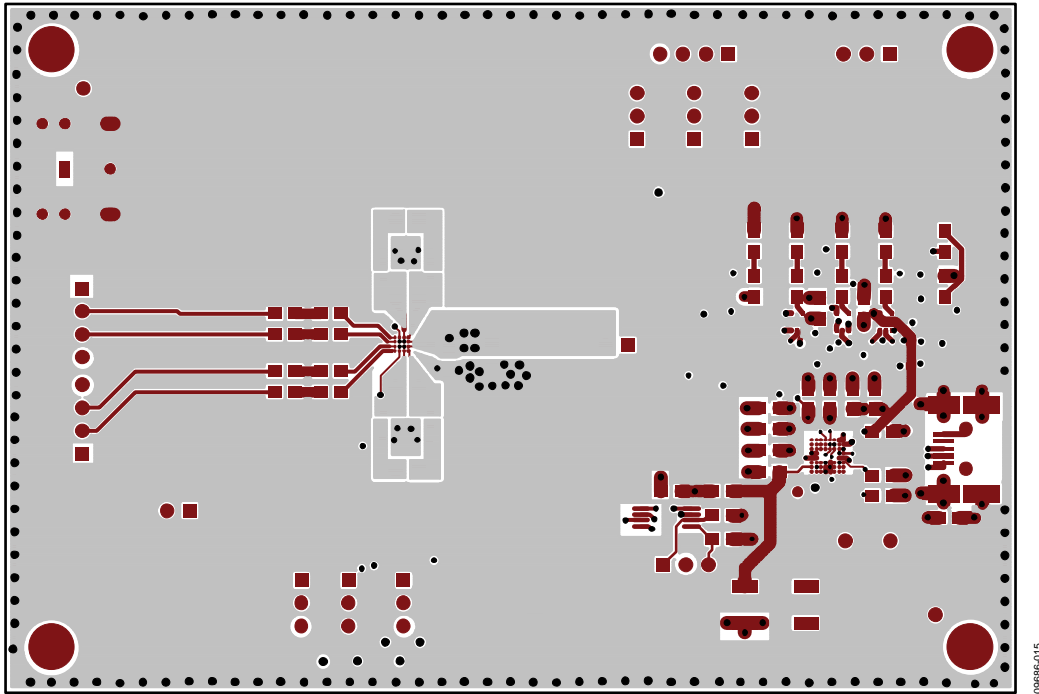

Figure 19. Evaluation Board Layout, Primary Side (Layer 1)

09866-015

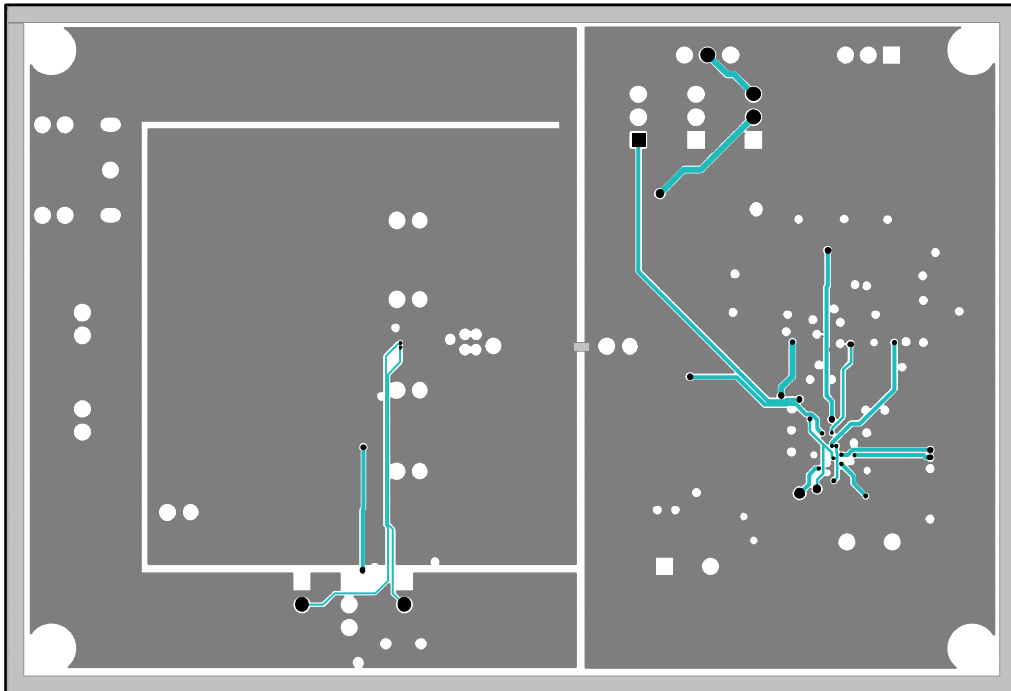
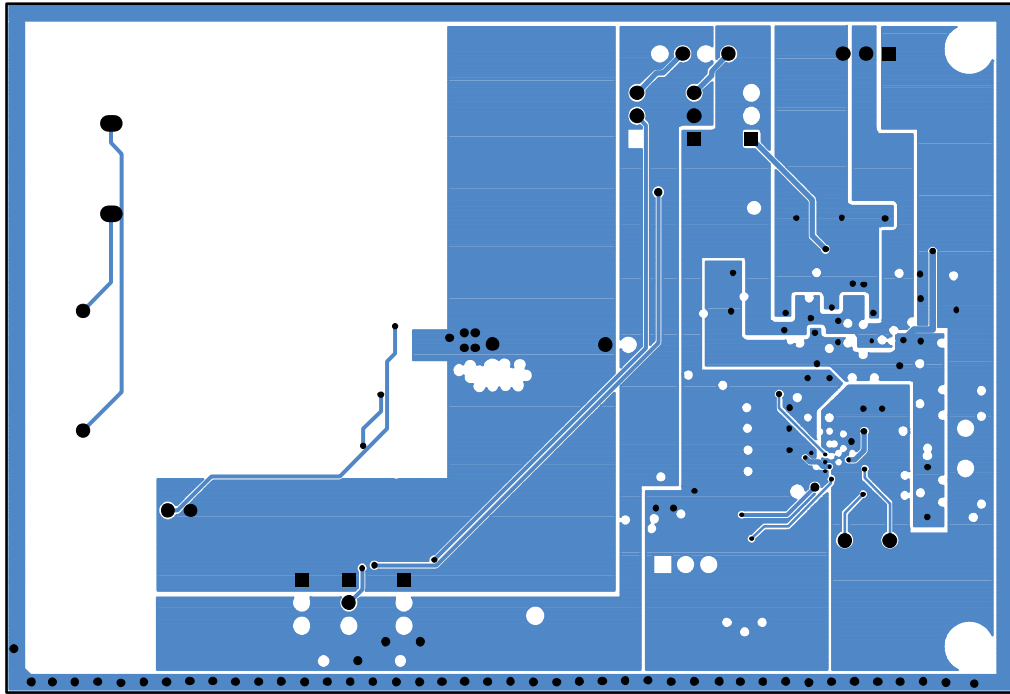

Figure 20. Evaluation Board Layout, Ground Plane (Layer 2)

09866-016



09886-017

Figure 21. Evaluation Board Layout, Power Plane (Layer 3)

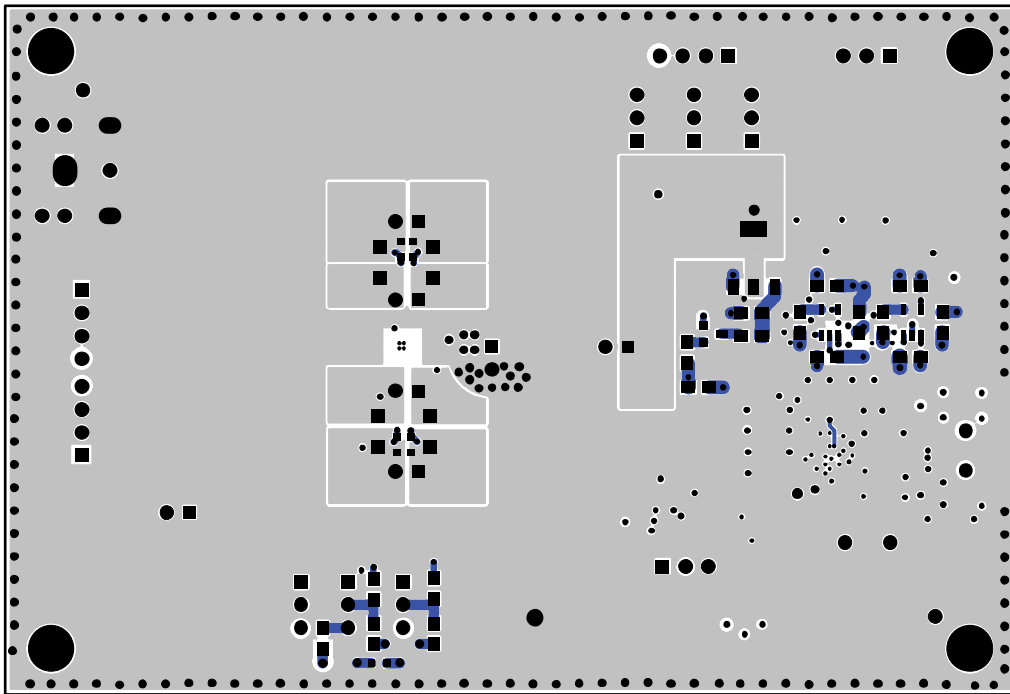

09886-018

Figure 22. Evaluation Board Layout, Secondary Side (Layer 4)

ORDERING INFORMATION

BILL OF MATERIALS

Table 6.

Item	Qty	Reference Designator	Description	Manufacturer	Part Number
1	4	B1, B2, B3, B4 ¹	Ferrite chip, 220 Ω, 2A, 0603	TDK Corporation	MPZ1608S221A
2	5	C1, C2, C4, C5, C19	Ceramic capacitor, 1.0 μF, 10 V, X7R, 0805	Kemet	C0805C105K8RACTU
3	5	C3, C6, C10, C11, C26	Ceramic capacitor, 10 μF, 10 V, 10%, X5R, 0805	Murata Electronics	GRM21BR61A106KE19L
4	2	C7, C8	Ceramic capacitor, 0.01 μF, 10%, 50V, X7R, 0603	AVX Corporation	06035C103KAT2A
5	8	C9, C12, C13, C14, C15, C16, C20, C21	Ceramic capacitor, 0.10 μF, 25 V, X5R, 0603	Taiyo Yuden	TMK107BJ104KA-T
6	2	C17, C18	Ceramic capacitor, 22 pF, 50 V, 0603, SMD	Panasonic - ECG	ECJ-1VC1H220J
7	4	C22, C23, C24, C25	Ceramic capacitor, 0.22 μF, 16 V, X7R, 0805	Panasonic - ECG	ECJ-2VB1C224K
8	2	C27, C28 ²	Ceramic capacitor, 0.10 μF, 25 V, X5R, 0603	Taiyo Yuden	TMK107BJ104KA-T
9	8	C29, C30, C31, C32, C33, C34, C35, C36 ³	Ceramic capacitor, 510 pF, 50 V, 5%, C0G, 0603	Murata Electronics	GRM1885C1H511JA01D
10	1	D1	LED MINISMD, red, 7.5 MCD, GAASP/GAP	Vishay/Semiconductors	TLMS2100-GS08
11	2	D2, D4	LED MINISMD, yellow, 7.5 MCD, GAASP/GAP	Vishay/Semiconductors	TLMY2100-GS08
12	2	D3, D5	LED, blue, 471 NM, clear, SMD	OSRAM Opto Semiconductors	LB M673-L1M2-35-Z
13	8	JP1, H1, JP2, JP3, JP4, JP9, JP10, JP11	Connector, header, breakaway, 0.100, 03POS, STR	Tyco Electronics	4-103747-0-03
14	3	H2, JP5, JP6	Connector, header, breakaway, 0.100 04POS, STR	Tyco Electronics	4-103747-0-04
15	7	H3, H4, H5, H6, JP7, H7, JP8	Connector, header, breakaway, 0.100 02POS, STR	Tyco Electronics	4-103747-0-02
16	1	J1	Connector mini USB, RCPT, RA, Type B, SMD	Tyco Electronics	1734035-2
17	1	J2	Connector jack stereo RA 3-pin 3.5 mm	CUI Inc.	SJ1-3523N
18	4	L1, L2, L3, L4 ⁴	0.47 μH, 1.4A, 80 mΩ, 3.2 mm × 1.6 mm	Murata Electronics	LQM31PNR47M00
19	1	Q1	Transistor PNP, -120 V, -2000 mA, SOT-223	Diodes/Zetex	FZT705TA
20	1	Q2	Transistor, GP NPN AMP SOT-23	Fairchild Semiconductor	MMBT3904
21	2	R1, R10	Resistor, 100 kΩ, 1/8 W, 1%, 0805, SMD	Panasonic - ECG	ERJ-6ENF1003V
22	1	R2	Resistor, 2.00 kΩ, 1/8 W, 1%, 0805, SMD	Yageo	RC0805FR-072KL
23	5	R3, R8, R9, R11, R25	Resistor, 475 Ω, 1/8 W, 1%, 0805, SMD	Panasonic - ECG	ERJ-6ENF4750V
24	2	R4, R5	Resistor, 10.0 kΩ, 1/8 W, 1%, 0805, SMD	Yageo	RC0805FR-0710KL
25	4	R6, R7, R20, R21 ⁵	Resistor, 4.99 kΩ, 1/8 W, 1%, 0805, SMD	Yageo	RC0805FR-074K99L
26	8	R14, R15, R16, R17, R18, R19, R22, R23 ⁵	Resistor, 0.0 Ω, 1/8 W, 0805, SMD	Panasonic - ECG	ERJ-6GEY0R00V
27	1	R24	Resistor, 4.99 kΩ, 1/8 W, 1%, 0805, SMD	Yageo	RC0805FR-074K99L
28	1	SW1	Switch TACT SMD, W/O GND, 160 g	Omron Electronics Inc	B3SN-3012P
29	1	U1	IC REG LDO, 150 mA, 3.3 V, TSOT-23-5	Analog Devices Inc	ADP1711AUJZ-3.3-R7
30	1	U2	IC REG LDO, 150 mA, 1.8 V, TSOT-23-5	Analog Devices Inc	ADP1711AUJZ-1.8-R7
31	1	U3	IC EEPROM, 256 Kb, 400 kHz, 8 TSSOP	Microchip Technology	24AA256-I/ST
32	1	U4	IC MCU MOBL-USB 56-VFBGA	Cypress Semiconductor	CY7C68053-56BAXIT
36	3	U5, U6, U7	Translator, 1-bit, unidirect, SC70-5	Fairchild Semiconductor	FXLP34P5X
37	1	U8	Class-D audio amplifier with ALC + I ² C	Analog Devices Inc.	SSM2380CBZ
38	1	Y1	Crystal, 24.000 MHz, 20 pF, 49 μs	ECS Inc.	ECS-240-20-4X

¹ B1 to B4 use 0 Ω links.² C28 is not populated.³ C29 to C36 are not populated.⁴ L1 to L4 are not populated.⁵ R18 to R21 are not populated.

NOTES

NOTES

**ESD Caution**

ESD (electrostatic discharge) sensitive device. Charged devices and circuit boards can discharge without detection. Although this product features patented or proprietary protection circuitry, damage may occur on devices subjected to high energy ESD. Therefore, proper ESD precautions should be taken to avoid performance degradation or loss of functionality.

Legal Terms and Conditions

By using the evaluation board discussed herein (together with any tools, components documentation or support materials, the "Evaluation Board"), you are agreeing to be bound by the terms and conditions set forth below ("Agreement") unless you have purchased the Evaluation Board, in which case the Analog Devices Standard Terms and Conditions of Sale shall govern. Do not use the Evaluation Board until you have read and agreed to the Agreement. Your use of the Evaluation Board shall signify your acceptance of the Agreement. This Agreement is made by and between you ("Customer") and Analog Devices, Inc. ("ADI"), with its principal place of business at One Technology Way, Norwood, MA 02062, USA. Subject to the terms and conditions of the Agreement, ADI hereby grants to Customer a free, limited, personal, temporary, non-exclusive, non-sublicensable, non-transferable license to use the Evaluation Board FOR EVALUATION PURPOSES ONLY. Customer understands and agrees that the Evaluation Board is provided for the sole and exclusive purpose referenced above, and agrees not to use the Evaluation Board for any other purpose. Furthermore, the license granted is expressly made subject to the following additional limitations: Customer shall not (i) rent, lease, display, sell, transfer, assign, sublicense, or distribute the Evaluation Board; and (ii) permit any Third Party to access the Evaluation Board. As used herein, the term "Third Party" includes any entity other than ADI, Customer, their employees, affiliates and in-house consultants. The Evaluation Board is NOT sold to Customer; all rights not expressly granted herein, including ownership of the Evaluation Board, are reserved by ADI. CONFIDENTIALITY. This Agreement and the Evaluation Board shall all be considered the confidential and proprietary information of ADI. Customer may not disclose or transfer any portion of the Evaluation Board to any other party for any reason. Upon discontinuation of use of the Evaluation Board or termination of this Agreement, Customer agrees to promptly return the Evaluation Board to ADI. ADDITIONAL RESTRICTIONS. Customer may not disassemble, decompile or reverse engineer chips on the Evaluation Board. Customer shall inform ADI of any occurred damages or any modifications or alterations it makes to the Evaluation Board, including but not limited to soldering or any other activity that affects the material content of the Evaluation Board. Modifications to the Evaluation Board must comply with applicable law, including but not limited to the RoHS Directive. TERMINATION. ADI may terminate this Agreement at any time upon giving written notice to Customer. Customer agrees to return to ADI the Evaluation Board at that time. LIMITATION OF LIABILITY. THE EVALUATION BOARD PROVIDED HEREUNDER IS PROVIDED "AS IS" AND ADI MAKES NO WARRANTIES OR REPRESENTATIONS OF ANY KIND WITH RESPECT TO IT. ADI SPECIFICALLY DISCLAIMS ANY REPRESENTATIONS, ENDORSEMENTS, GUARANTEES, OR WARRANTIES, EXPRESS OR IMPLIED, RELATED TO THE EVALUATION BOARD INCLUDING, BUT NOT LIMITED TO, THE IMPLIED WARRANTY OF MERCHANTABILITY, TITLE, FITNESS FOR A PARTICULAR PURPOSE OR NON-INFRINGEMENT OF INTELLECTUAL PROPERTY RIGHTS. IN NO EVENT WILL ADI AND ITS LICENSORS BE LIABLE FOR ANY INCIDENTAL, SPECIAL, INDIRECT, OR CONSEQUENTIAL DAMAGES RESULTING FROM CUSTOMER'S POSSESSION OR USE OF THE EVALUATION BOARD, INCLUDING BUT NOT LIMITED TO LOST PROFITS, DELAY COSTS, LABOR COSTS OR LOSS OF GOODWILL. ADI'S TOTAL LIABILITY FROM ANY AND ALL CAUSES SHALL BE LIMITED TO THE AMOUNT OF ONE HUNDRED US DOLLARS (\$100.00). EXPORT. Customer agrees that it will not directly or indirectly export the Evaluation Board to another country, and that it will comply with all applicable United States federal laws and regulations relating to exports. GOVERNING LAW. This Agreement shall be governed by and construed in accordance with the substantive laws of the Commonwealth of Massachusetts (excluding conflict of law rules). Any legal action regarding this Agreement will be heard in the state or federal courts having jurisdiction in Suffolk County, Massachusetts, and Customer hereby submits to the personal jurisdiction and venue of such courts. The United Nations Convention on Contracts for the International Sale of Goods shall not apply to this Agreement and is expressly disclaimed.