





Grayhill, Inc.

## 62S11-N9-PH

Numéro d'article:	62S11-N9-PH
Fabricant / marque:	Grayhill, Inc.
Description du produit	ROTARY ENCODER OPTICAL 32PPR
Feuilles de données:	 <a href="#">62S11-N9-PH.pdf</a>
Statut RoHS	 Sans plomb / Conforme RoHS
Etat du stock	2219 pcs stock
Bateau de	Hong Kong
Manière d'expédition	DHL/Fedex/TNT/UPS/EMS

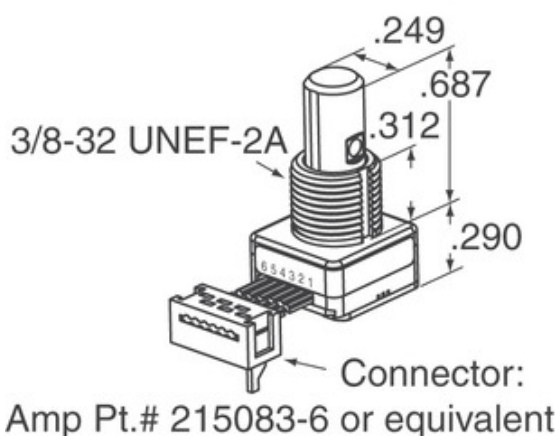

L'image peut être une représentation. Voir les spécifications pour les détails du produit.







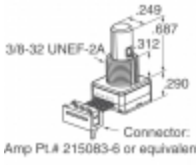
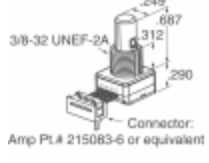

### Spécifications de 62S11-N9-PH

NUMÉRO D'ARTICLE	62S11-N9-PH
FABRICANT	Grayhill, Inc.
LA DESCRIPTION	ROTARY ENCODER OPTICAL 32PPR
ÉTAT SANS PLOMB / ÉTAT ROHS	Sans plomb / Conforme RoHS
QUANTITÉ DISPONIBLE	2219 pcs
FICHE TECHNIQUE	 <a href="#">62S11-N9-PH.pdf</a>
TENSION - ALIMENTATION	5V
STYLE DE RACCORDEMENT	PC Pin
SÉRIES	62S
VIE ROTATIONAL (CYCLES MIN)	1M
IMPULSIONS PAR TOUR	32
LE TYPE DE SORTIE	Quadrature (Incremental)
ORIENTATION	Vertical
TYPE DE MONTAGE	PCB, Through Hole
NIVEAU DE SENSIBILITÉ À L'HUMIDITÉ (MSL)	1 (Unlimited)
STATUT SANS PLOMB / STATUT ROHS	Lead free / RoHS Compliant
TYPE DE CODEUR	Optical
DETENT	No
COMMUTATEUR INTÉGRÉ	Yes
TYPE D'ACTIONNEUR	1/4" Dia Flatted End

### Tags associés

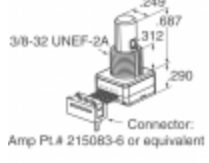
Grayhill, Inc. 62S11-N9-PH	Distributeur 62S11-N9-PH	62S11-N9-PH Fournisseur
Prix 62S11-N9-PH	62S11-N9-PH Photos	Image 62S11-N9-PH
62S11-N9-PH PDF Fiche technique	62S11-N9-PH Télécharger la fiche technique	62S11-N9-PH Fiche technique
Action 62S11-N9-PH	Acheter 62S11-N9-PH	Acheter Grayhill, Inc. 62S11-N9-PH
Grayhill, Inc. 62S11-N9-PH	Grayhill, Inc. Fournisseur	Distributeur Grayhill, Inc.
Grayhill, Inc. 62S11-N9-PH	Grayhill Inc. 62S11-N9-PH	

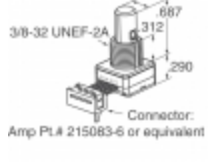
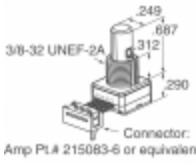
### Produits connexes

 <p><b>62S15-H0-020C</b> Fabricants: Grayhill, Inc. La description: ROTARY ENCODER OPTICAL 24PPR En stock: 2286 pcs</p> <p><b>RFQ</b></p>	 <p><b>62S11-N9-060C</b> Fabricants: Grayhill, Inc. La description: ROTARY ENCODER OPTICAL 32PPR En stock: 2192 pcs</p> <p><b>RFQ</b></p>
 <p><b>62S11-N9-060SH</b> Fabricants: Grayhill, Inc. La description: ROTARY ENCODER OPTICAL 32PPR En stock: 1801 pcs</p> <p><b>RFQ</b></p>	 <p><b>62S15-H0-PH</b> Fabricants: Grayhill, Inc. La description: ROTARY ENCODER OPTICAL 24PPR En stock: 2290 pcs</p> <p><b>RFQ</b></p>
 <p><b>62S11-N5-PV</b> Fabricants: Grayhill, Inc. La description: ROTARY ENCODER OPTICAL 32PPR En stock: 2220 pcs</p> <p><b>RFQ</b></p>	 <p><b>62S15-H0-040CH</b> Fabricants: Grayhill, Inc. La description: ROTARY ENCODER OPTICAL 24PPR En stock: 1921 pcs</p> <p><b>RFQ</b></p>
 <p><b>62S11-N9-120S</b> Fabricants: Grayhill, Inc. La description: ROTARY ENCODER OPTICAL 32PPR En stock: 1784 pcs</p> <p><b>RFQ</b></p>	 <p><b>62S15-H9-020C</b> Fabricants: Grayhill, Inc. La description: ROTARY ENCODER OPTICAL 24PPR En stock: 1833 pcs</p> <p><b>RFQ</b></p>
 <p><b>62S11-N5-120S</b> Fabricants: Grayhill, Inc. La description: ROTARY ENCODER OPTICAL 32PPR En stock: 1675 pcs</p> <p><b>RFQ</b></p>	 <p><b>62S11-N5-P</b> Fabricants: Grayhill, Inc. La description: ROTARY ENCODER OPTICAL 32PPR En stock: 1885 pcs</p> <p><b>RFQ</b></p>
 <p><b>62S15-H0-P</b> Fabricants: Grayhill, Inc. La description: ROTARY ENCODER OPTICAL 24PPR En stock: 2136 pcs</p> <p><b>RFQ</b></p>	 <p><b>62S15-H0-040C</b> Fabricants: Grayhill, Inc. La description: ROTARY ENCODER OPTICAL 24PPR En stock: 1793 pcs</p> <p><b>RFQ</b></p>

Copyright © 2020 Distributeur fiable de composants électroniques

Email: [Info@infinity-electronic.com](mailto:Info@infinity-electronic.com)

Adresse: 17F, bâtiment commercial Gaylord, 114-118 Lockhart Road, Wan Chai, Hong Kong

