





Grayhill, Inc.

62S11-L9-040C

Numéro d'article:	62S11-L9-040C
Fabricant / marque:	Grayhill, Inc.
Description du produit:	ROTARY ENCODER OPTICAL 32PPR
Feuilles de données:	 62S11-L9-040C.pdf
Statut RoHS	 Sans plomb / Conforme RoHS
Etat du stock	1938 pcs stock
Bateau de	Hong Kong
Manière d'expédition	DHL/Fedex/TNT/UPS/EMS

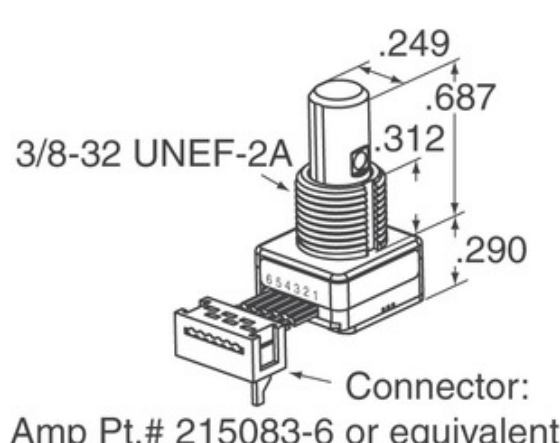
[DEMANDE DE DEVIS](#)

L'image peut être une représentation. Voir les spécifications pour les détails du produit.





Spécifications de 62S11-L9-040C

NUMÉRO D'ARTICLE	62S11-L9-040C
FABRICANT	Grayhill, Inc.
LA DESCRIPTION	ROTARY ENCODER OPTICAL 32PPR
ÉTAT SANS PLOMB / ÉTAT ROHS	Sans plomb / Conforme RoHS
QUANTITÉ DISPONIBLE	1938 pcs
FICHE TECHNIQUE	 62S11-L9-040C.pdf
TENSION - ALIMENTATION	5V
STYLE DE RACCORDEMENT	Cable with Connector
SÉRIES	62S
VIE ROTATIONAL (CYCLES MIN)	1M
IMPULSIONS PAR TOUR	32
LE TYPE DE SORTIE	Quadrature (Incremental)
AUTRES NOMS	62S11L9040C
ORIENTATION	Vertical
TYPE DE MONTAGE	Panel Mount
NIVEAU DE SENSIBILITÉ À L'HUMIDITÉ (MSL)	1 (Unlimited)
STATUT SANS PLOMB / STATUT ROHS	Lead free / RoHS Compliant
TYPE DE CODEUR	Optical
DETENT	Yes
COMMUTATEUR INTÉGRÉ	Yes
TYPE D'ACTIONNEUR	1/4" Dia Flatted End

Tags associés

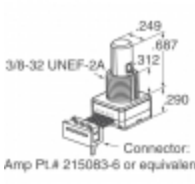
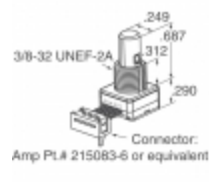
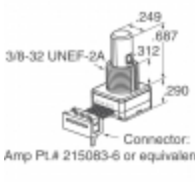
Grayhill, Inc. 62S11-L9-040C	Distributeur 62S11-L9-040C	62S11-L9-040C Fournisseur
Prix 62S11-L9-040C	62S11-L9-040C Photos	Image 62S11-L9-040C
62S11-L9-040C PDF Fiche technique	62S11-L9-040C Télécharger la fiche technique	62S11-L9-040C Fiche technique
Action 62S11-L9-040C	Acheter 62S11-L9-040C	Acheter Grayhill, Inc. 62S11-L9-040C
Grayhill, Inc. 62S11-L9-040C	Grayhill, Inc. Fournisseur	Distributeur Grayhill, Inc.
Grayhill, Inc. 62S11-L9-040C	Grayhill Inc. 62S11-L9-040C	

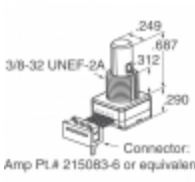
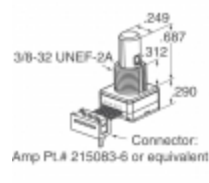
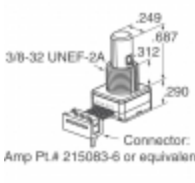
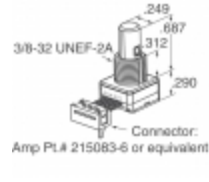
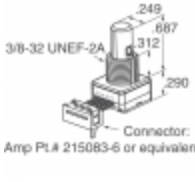
Produits connexes

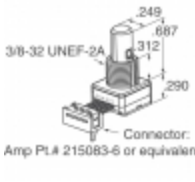
 <p>62S11-L5-PH Fabricants: Grayhill, Inc. La description: ROTARY ENCODER OPTICAL 32PPR En stock: 2218 pcs</p> <p>RFQ</p>	 <p>62S11-L9-020C Fabricants: Grayhill, Inc. La description: ROTARY ENCODER OPTICAL 32PPR En stock: 1773 pcs</p> <p>RFQ</p>
 <p>62S11-M0-020C Fabricants: Grayhill, Inc. La description: ROTARY ENCODER OPT 32PPR 2" CBL En stock: 1812 pcs</p> <p>RFQ</p>	 <p>62S11-L9-PH Fabricants: Grayhill, Inc. La description: ROTARY ENCODER OPTICAL 32PPR En stock: 1972 pcs</p> <p>RFQ</p>
 <p>62S11-M0-040CH Fabricants: Grayhill, Inc. La description: ROTARY ENCODER OPT 32PPR 2" CBL En stock: 1915 pcs</p> <p>RFQ</p>	 <p>62S11-L9-020S Fabricants: Grayhill, Inc. La description: ROTARY ENCODER OPTICAL 32PPR En stock: 2134 pcs</p> <p>RFQ</p>
 <p>62S11-M0-020SH Fabricants: Grayhill, Inc. La description: ROTARY ENCODER OPT 32PPR 2" CBL En stock: 2051 pcs</p> <p>RFQ</p>	 <p>62S11-L5-P Fabricants: Grayhill, Inc. La description: ROTARY ENCODER OPTICAL 32PPR En stock: 2265 pcs</p> <p>RFQ</p>
 <p>62S11-M0-030CH Fabricants: Grayhill, Inc. La description: ROTARY ENCODER OPTICAL 32PPR En stock: 2151 pcs</p> <p>RFQ</p>	 <p>62S11-L9-020CH Fabricants: Grayhill, Inc. La description: ROTARY ENCODER OPTICAL 32PPR En stock: 2264 pcs</p> <p>RFQ</p>
 <p>62S11-M0-050C Fabricants: Grayhill, Inc. La description: ROTARY ENCODER OPT 32PPR 5" CBL En stock: 2292 pcs</p> <p>RFQ</p>	 <p>62S11-L9-020SH Fabricants: Grayhill, Inc. La description: ROTARY ENCODER OPTICAL 32PPR En stock: 1952 pcs</p> <p>RFQ</p>