





Grayhill, Inc.

62S11-L9-020C

Número d'article:	62S11-L9-020C
Fabricant / marque:	Grayhill, Inc.
Description du produit:	ROTARY ENCODER OPTICAL 32PPR
Feuilles de données:	 62S11-L9-020C.pdf
Statut RoHS	 Sans plomb / Conforme RoHS
Etat du stock	1773 pcs stock
Bateau de	Hong Kong
Manière d'expédition	DHL/Fedex/TNT/UPS/EMS

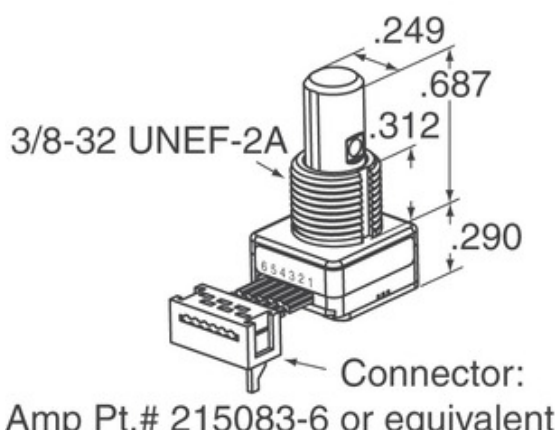
[DEMANDE DE DEVIS](#)

L'image peut être une représentation. Voir les spécifications pour les détails du produit.





Spécifications de 62S11-L9-020C

NUMÉRO D'ARTICLE	62S11-L9-020C
FABRICANT	Grayhill, Inc.
LA DESCRIPTION	ROTARY ENCODER OPTICAL 32PPR
ÉTAT SANS PLOMB / ÉTAT ROHS	Sans plomb / Conforme RoHS
QUANTITÉ DISPONIBLE	1773 pcs
FICHE TECHNIQUE	 62S11-L9-020C.pdf
TENSION - ALIMENTATION	5V
STYLE DE RACCORDEMENT	Cable with Connector
SÉRIES	62S
VIE ROTATIONAL (CYCLES MIN)	1M
IMPULSIONS PAR TOUR	32
LE TYPE DE SORTIE	Quadrature (Incremental)
AUTRES NOMS	62S11L9020C
ORIENTATION	Vertical
TYPE DE MONTAGE	Panel Mount
NIVEAU DE SENSIBILITÉ À L'HUMIDITÉ (MSL)	1 (Unlimited)
STATUT SANS PLOMB / STATUT ROHS	Lead free / RoHS Compliant
TYPE DE CODEUR	Optical
DETENT	Yes
COMMUTEUR INTÉGRÉ	Yes
TYPE D'ACTIONNEUR	1/4" Dia Flatted End

Tags associés

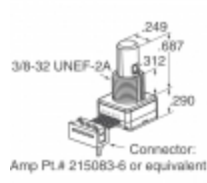
Grayhill, Inc. 62S11-L9-020C	Distributeur 62S11-L9-020C	62S11-L9-020C Fournisseur
Prix 62S11-L9-020C	62S11-L9-020C Photos	Image 62S11-L9-020C
62S11-L9-020C PDF Fiche technique	62S11-L9-020C Télécharger la fiche technique	62S11-L9-020C Fiche technique
Action 62S11-L9-020C	Acheter 62S11-L9-020C	Acheter Grayhill, Inc. 62S11-L9-020C
Grayhill, Inc. 62S11-L9-020C	Grayhill, Inc. Fournisseur	Distributeur Grayhill, Inc.
Grayhill, Inc. 62S11-L9-020C	Grayhill Inc. 62S11-L9-020C	

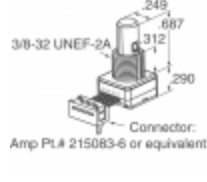
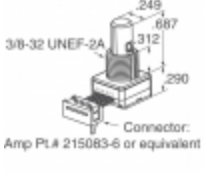
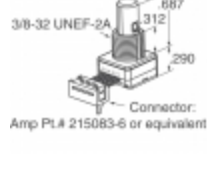
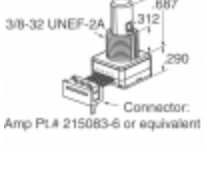
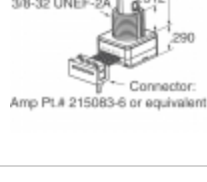
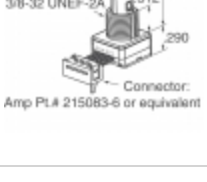
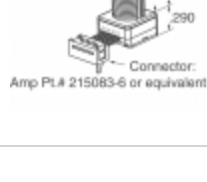
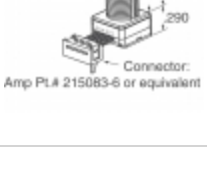
Produits connexes

 <p>62S11-L5-050CH Fabricants: Grayhill, Inc. La description: ROTARY ENCODER OPTICAL 32PPR En stock: 2186 pcs</p> <p>RFQ</p>	 <p>62S11-L5-PH Fabricants: Grayhill, Inc. La description: ROTARY ENCODER OPTICAL 32PPR En stock: 2218 pcs</p> <p>RFQ</p>
 <p>62S11-L9-PH Fabricants: Grayhill, Inc. La description: ROTARY ENCODER OPTICAL 32PPR En stock: 1972 pcs</p> <p>RFQ</p>	 <p>62S11-L9-020CH Fabricants: Grayhill, Inc. La description: ROTARY ENCODER OPTICAL 32PPR En stock: 2264 pcs</p> <p>RFQ</p>
 <p>62S11-L9-040C Fabricants: Grayhill, Inc. La description: ROTARY ENCODER OPTICAL 32PPR En stock: 1938 pcs</p> <p>RFQ</p>	 <p>62S11-L9-020S Fabricants: Grayhill, Inc. La description: ROTARY ENCODER OPTICAL 32PPR En stock: 2134 pcs</p> <p>RFQ</p>
 <p>62S11-L9-020SH Fabricants: Grayhill, Inc. La description: ROTARY ENCODER OPTICAL 32PPR En stock: 1952 pcs</p> <p>RFQ</p>	 <p>62S11-L5-040C Fabricants: Grayhill, Inc. La description: ROTARY ENCODER OPTICAL 32PPR En stock: 1990 pcs</p> <p>RFQ</p>
 <p>62S11-L5-035C Fabricants: Grayhill, Inc. La description: ROTARY ENCODER OPTICAL 32PPR En stock: 1861 pcs</p> <p>RFQ</p>	 <p>62S11-L5-060C Fabricants: Grayhill, Inc. La description: ROTARY ENCODER OPTICAL 32PPR En stock: 2163 pcs</p> <p>RFQ</p>
 <p>62S11-L5-P Fabricants: Grayhill, Inc. La description: ROTARY ENCODER OPTICAL 32PPR En stock: 2265 pcs</p> <p>RFQ</p>	 <p>62S11-M0-020C Fabricants: Grayhill, Inc. La description: ROTARY ENCODER OPT 32PPR 2" CBL En stock: 1812 pcs</p> <p>RFQ</p>

Copyright © 2020 Distributeur fiable de composants électroniques

Email: Info@infinity-electronic.com

Adresse: 17F, bâtiment commercial Gaylord, 114-118 Lockhart Road, Wan Chai, Hong Kong

