





Grayhill, Inc.

62S11-N9-060C

Numéro d'article:	62S11-N9-060C
Fabricant / marque:	Grayhill, Inc.
Description du produit:	ROTARY ENCODER OPTICAL 32PPR
Feuilles de données:	 62S11-N9-060C.pdf
Statut RoHS	 Sans plomb / Conforme RoHS
Etat du stock	2192 pcs stock
Bateau de	Hong Kong
Manière d'expédition	DHL/Fedex/TNT/UPS/EMS

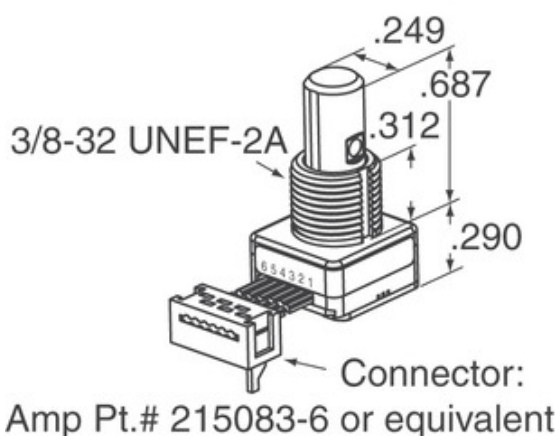
[DEMANDE DE DEVIS](#)

L'image peut être une représentation. Voir les spécifications pour les détails du produit.







Spécifications de 62S11-N9-060C

NUMÉRO D'ARTICLE	62S11-N9-060C
FABRICANT	Grayhill, Inc.
LA DESCRIPTION	ROTARY ENCODER OPTICAL 32PPR
ÉTAT SANS PLOMB / ÉTAT ROHS	Sans plomb / Conforme RoHS
QUANTITÉ DISPONIBLE	2192 pcs
FICHE TECHNIQUE	 62S11-N9-060C.pdf
TENSION - ALIMENTATION	5V
STYLE DE RACCORDEMENT	Cable with Connector
SÉRIES	62S
VIE ROTATIONAL (CYCLES MIN)	1M
IMPULSIONS PAR TOUR	32
LE TYPE DE SORTIE	Quadrature (Incremental)
AUTRES NOMS	62S11N9060C
ORIENTATION	Vertical
TYPE DE MONTAGE	Panel Mount
NIVEAU DE SENSIBILITÉ À L'HUMIDITÉ (MSL)	1 (Unlimited)
STATUT SANS PLOMB / STATUT ROHS	Lead free / RoHS Compliant
TYPE DE CODEUR	Optical
DETENT	No
COMMUTATEUR INTÉGRÉ	Yes
TYPE D'ACTIONNEUR	1/4" Dia Flatted End

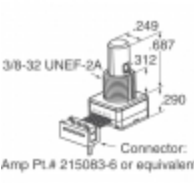
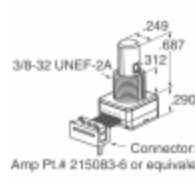
Tags associés

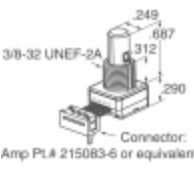
Grayhill, Inc. 62S11-N9-060C	Distributeur 62S11-N9-060C	62S11-N9-060C Fournisseur
Prix 62S11-N9-060C	62S11-N9-060C Photos	Image 62S11-N9-060C
62S11-N9-060C PDF Fiche technique	62S11-N9-060C Télécharger la fiche technique	62S11-N9-060C Fiche technique
Action 62S11-N9-060C	Acheter 62S11-N9-060C	Acheter Grayhill, Inc. 62S11-N9-060C
Grayhill, Inc. 62S11-N9-060C	Grayhill, Inc. Fournisseur	Distributeur Grayhill, Inc.
Grayhill, Inc. 62S11-N9-060C	Grayhill Inc. 62S11-N9-060C	

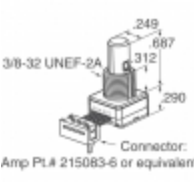
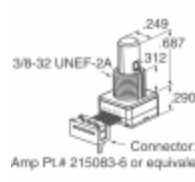
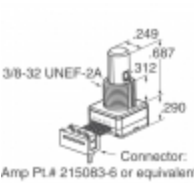
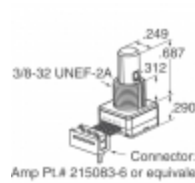
Produits connexes

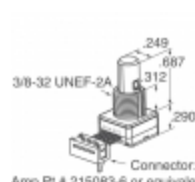
 <p>62S11-N5-060SH Fabricants: Grayhill, Inc. La description: ROTARY ENCODER OPTICAL 32PPR En stock: 2263 pcs</p> <p>RFQ</p>	 <p>62S11-N9-060SH Fabricants: Grayhill, Inc. La description: ROTARY ENCODER OPTICAL 32PPR En stock: 1801 pcs</p> <p>RFQ</p>
 <p>62S15-H0-020C Fabricants: Grayhill, Inc. La description: ROTARY ENCODER OPTICAL 24PPR En stock: 2286 pcs</p> <p>RFQ</p>	 <p>62S15-H0-040CH Fabricants: Grayhill, Inc. La description: ROTARY ENCODER OPTICAL 24PPR En stock: 1921 pcs</p> <p>RFQ</p>
 <p>62S11-N5-080SH Fabricants: Grayhill, Inc. La description: ROTARY ENCODER OPTICAL 32PPR En stock: 1942 pcs</p> <p>RFQ</p>	 <p>62S11-N5-PV Fabricants: Grayhill, Inc. La description: ROTARY ENCODER OPTICAL 32PPR En stock: 2220 pcs</p> <p>RFQ</p>
 <p>62S11-N9-PH Fabricants: Grayhill, Inc. La description: ROTARY ENCODER OPTICAL 32PPR En stock: 2219 pcs</p> <p>RFQ</p>	 <p>62S11-N5-100C Fabricants: Grayhill, Inc. La description: ROTARY ENCODER OPTICAL 32PPR En stock: 1789 pcs</p> <p>RFQ</p>
 <p>62S11-N9-120S Fabricants: Grayhill, Inc. La description: ROTARY ENCODER OPTICAL 32PPR En stock: 1784 pcs</p> <p>RFQ</p>	 <p>62S11-N5-120S Fabricants: Grayhill, Inc. La description: ROTARY ENCODER OPTICAL 32PPR En stock: 1675 pcs</p> <p>RFQ</p>
 <p>62S15-H0-040C Fabricants: Grayhill, Inc. La description: ROTARY ENCODER OPTICAL 24PPR En stock: 1793 pcs</p> <p>RFQ</p>	 <p>62S11-N5-P Fabricants: Grayhill, Inc. La description: ROTARY ENCODER OPTICAL 32PPR En stock: 1885 pcs</p> <p>RFQ</p>

Copyright © 2020 Distributeur fiable de composants électroniques

Email: Info@infinity-electronic.com

Adresse: 17F, bâtiment commercial Gaylord, 114-118 Lockhart Road, Wan Chai, Hong Kong

