



Agastat Relays / TE Connectivity

OAC-5

Numéro d'article:

Fabricant / marque:

Description du produit

Feuilles de données:

Statut RoHS

Etat du stock

Bateau de

Manière d'expédition

OAC-5

Agastat Relays / TE Connectivity

AC OUTPUT MODULE 3A

 OAC-5.pdf

 Sans plomb / Conforme RoHS

4639 pcs stock

Hong Kong

DHL/Fedex/TNT/UPS/EMS

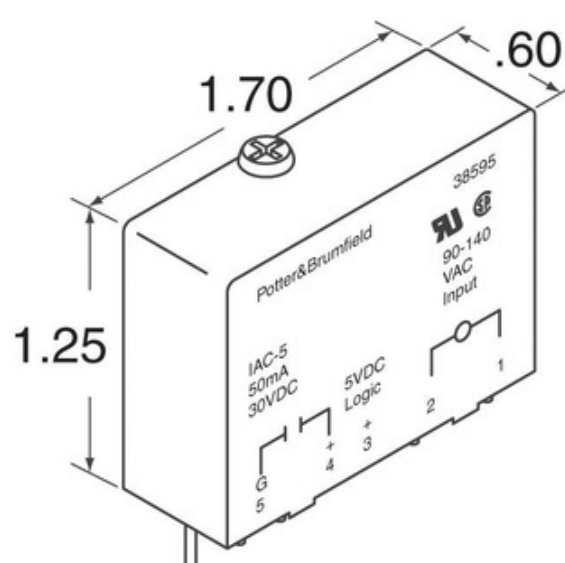

L'image peut être une représentation. Voir les spécifications pour les détails du produit.

[DEMANDE DE DEVIS](#)









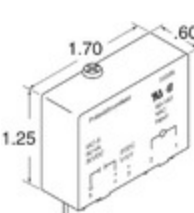

Spécifications de OAC-5

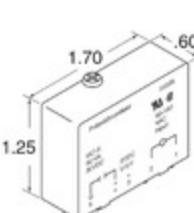
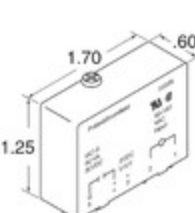
NUMÉRO D'ARTICLE	OAC-5
FABRICANT	Agastat Relays / TE Connectivity
LA DESCRIPTION	AC OUTPUT MODULE 3A
ÉTAT SANS PLOMB / ÉTAT ROHS	Sans plomb / Conforme RoHS
QUANTITÉ DISPONIBLE	4639 pcs
FICHE TECHNIQUE	 OAC-5.pdf
TENSION - SORTIE	24 ~ 280VAC
TENSION - ENTRÉE	5VDC
TYPE	AC Output Module
ACTIVER LE TEMPS	8.33ms
TEMPS DE DÉSACTIVATION	8.33ms
STYLE	Standard
SÉRIES	OAC
AUTRES NOMS	6-1393028-9 PB539
STATUT SANS PLOMB / STATUT ROHS	Lead free / RoHS Compliant
CARACTÉRISTIQUES	Hold Down Screw
DESCRIPTION DÉTAILLÉE	AC Output Module Output Module 3A 24 ~ 280VAC Output 5VDC Supply
COURANT - SORTIE	3A
COURANT - ENTRÉE	20mA
COULEUR	Black

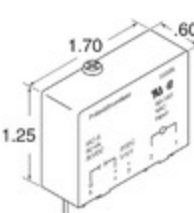
Tags associés

Agastat Relays / TE Connectivity OAC-5	Distributeur OAC-5	OAC-5 Fournisseur
Prix OAC-5	OAC-5 Photos	Image OAC-5
OAC-5 PDF Fiche technique	OAC-5 Télécharger la fiche technique	OAC-5 Fiche technique
Action OAC-5	Acheter OAC-5	Acheter Agastat Relays / TE Connectivity OAC-5
Agastat Relays / TE Connectivity OAC-5	Agastat Relays / TE Connectivity Fournisseur	Distributeur Agastat Relays / TE Connectivity
Agastat Relays / TE Connectivity OAC-5	Axicom Relays / TE Connectivity OAC-5	Buchanan Terminal Blocks / TE Connectivity OAC-5
CGS Resistors / TE Connectivity OAC-5	CII / TE Connectivity OAC-5	Elcon Connectors / TE Connectivity OAC-5
Holsworthy Resistors / TE Connectivity OAC-5	Kilovac Relays / TE Connectivity OAC-5	Neohm Resistors / TE Connectivity OAC-5
OEG Relays / TE Connectivity OAC-5	Products Unlimited Transformers & Relays / TE Conn OAC-5	Q-Cee's / TE Connectivity OAC-5
Schrack Relays / TE Connectivity OAC-5	Sigma Inductors / TE Connectivity OAC-5	TE Connectivity's Agastat Relays OAC-5
TE Connectivity's Axicom Relays OAC-5	TE Connectivity's Buchanan Terminal Blocks OAC-5	TE Connectivity's CGS Resistors OAC-5
TE Connectivity's CII OAC-5	TE Connectivity's Elcon Connectors OAC-5	TE Connectivity's Holsworthy Resistors OAC-5
TE Connectivity's Neohm Resistors OAC-5	TE Connectivity's OEG Relays OAC-5	TE Connectivity's Q-Cee's OAC-5
TE Connectivity's Schrack Relays OAC-5	TE Connectivity's Sigma Inductors OAC-5	TE Connectivity's Products Unlimited Transformers OAC-5
TE Connectivity's Kilovac Relays OAC-5		

Produits connexes

 <p>OAC-24 Fabricants: Agastat Relays / TE Connectivity La description: AC OUTPUT MODULE 3A En stock: 4371 pcs</p> <p>RFQ</p>	 <p>OAC24 Fabricants: Crydom La description: AC OUTPUT MODULE 3.5A En stock: 2890 pcs</p> <p>RFQ</p>
 <p>OAC-5H Fabricants: Agastat Relays / TE Connectivity La description: AC OUTPUT MODULE 5A En stock: 4073 pcs</p> <p>RFQ</p>	 <p>OAC-5A Fabricants: Agastat Relays / TE Connectivity La description: AC OUTPUT MODULE 3A En stock: 4645 pcs</p> <p>RFQ</p>
 <p>OAC24A Fabricants: Crydom La description: AC OUTPUT MODULE 3.5A En stock: 3505 pcs</p> <p>RFQ</p>	 <p>OAC-24A Fabricants: Agastat Relays / TE Connectivity La description: AC OUTPUT MODULE 3A En stock: 8040 pcs</p> <p>RFQ</p>
 <p>OAC-15 Fabricants: Agastat Relays / TE Connectivity La description: AC OUTPUT MODULE 3A En stock: 5767 pcs</p> <p>RFQ</p>	 <p>OAC24RN Fabricants: Crydom La description: AC OUTPUT MODULE 3.5A En stock: 2448 pcs</p> <p>RFQ</p>
 <p>OAC-15A Fabricants: Agastat Relays / TE Connectivity La description: AC OUTPUT MODULE 3A En stock: 4673 pcs</p> <p>RFQ</p>	 <p>OAC-24H Fabricants: Agastat Relays / TE Connectivity La description: AC OUTPUT MODULE 5A En stock: 5816 pcs</p> <p>RFQ</p>
 <p>OAC15A Fabricants: Crydom La description: AC OUTPUT MODULE 3A En stock: 3683 pcs</p> <p>RFQ</p>	 <p>OAC15 Fabricants: Crydom La description: AC OUTPUT MODULE 3A En stock: 2489 pcs</p> <p>RFQ</p>