





Grayhill, Inc.

62S11-M0-PV

| | |
|-------------------------|--|
| Numéro d'article: | 62S11-M0-PV |
| Fabricant / marque: | Grayhill, Inc. |
| Description du produit: | ROTARY ENCODER OPTICAL 32PPR |
| Feuilles de données: |  62S11-M0-PV.pdf |
| Statut RoHS |  Sans plomb / Conforme RoHS |
| Etat du stock | 2105 pcs stock |
| Bateau de | Hong Kong |
| Manière d'expédition | DHL/Fedex/TNT/UPS/EMS |

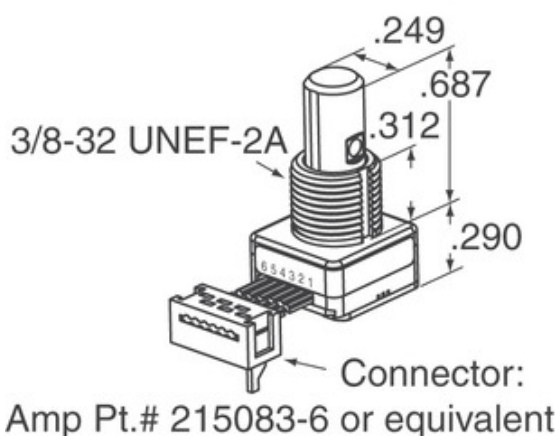
[DEMANDE DE DEVIS](#)

L'image peut être une représentation. Voir les spécifications pour les détails du produit.





Spécifications de 62S11-M0-PV

| | |
|--|---|
| NUMÉRO D'ARTICLE | 62S11-M0-PV |
| FABRICANT | Grayhill, Inc. |
| LA DESCRIPTION | ROTARY ENCODER OPTICAL 32PPR |
| ÉTAT SANS PLOMB / ÉTAT ROHS | Sans plomb / Conforme RoHS |
| QUANTITÉ DISPONIBLE | 2105 pcs |
| FICHE TECHNIQUE |  62S11-M0-PV.pdf |
| TENSION - ALIMENTATION | 5V |
| STYLE DE RACCORDEMENT | PC Pin |
| SÉRIES | 62S |
| VIE ROTATIONAL (CYCLES MIN) | 1M |
| IMPULSIONS PAR TOUR | 32 |
| LE TYPE DE SORTIE | Quadrature (Incremental) |
| AUTRES NOMS | 62S11M0PV |
| ORIENTATION | Vertical |
| TYPE DE MONTAGE | PCB, Through Hole |
| NIVEAU DE SENSIBILITÉ À L'HUMIDITÉ (MSL) | 1 (Unlimited) |
| STATUT SANS PLOMB / STATUT ROHS | Lead free / RoHS Compliant |
| TYPE DE CODEUR | Optical |
| DETENT | Yes |
| COMMUTATEUR INTÉGRÉ | No |
| TYPE D'ACTIONNEUR | 1/4" Dia Flatted End |

Tags associés

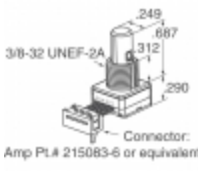
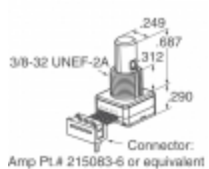
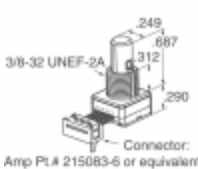
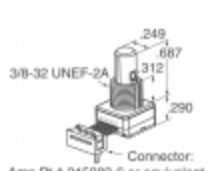
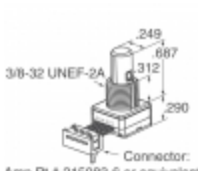
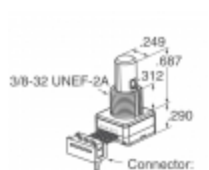
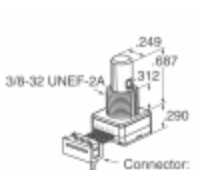
| | | |
|---------------------------------|--|------------------------------------|
| Grayhill, Inc. 62S11-M0-PV | Distributeur 62S11-M0-PV | 62S11-M0-PV Fournisseur |
| Prix 62S11-M0-PV | 62S11-M0-PV Photos | Image 62S11-M0-PV |
| 62S11-M0-PV PDF Fiche technique | 62S11-M0-PV Télécharger la fiche technique | 62S11-M0-PV Fiche technique |
| Action 62S11-M0-PV | Acheter 62S11-M0-PV | Acheter Grayhill, Inc. 62S11-M0-PV |
| Grayhill, Inc. 62S11-M0-PV | Grayhill, Inc. Fournisseur | Distributeur Grayhill, Inc. |
| Grayhill, Inc. 62S11-M0-PV | Grayhill Inc. 62S11-M0-PV | |

Produits connexes

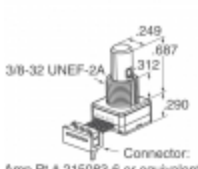
| | |
|---|--|
|  <p>62S11-M0-210SH Fabricants: Grayhill, Inc. La description: ROTARY ENCODER OPT 32PPR 20" CBL En stock: 2126 pcs</p> <p>RFQ</p> |  <p>62S11-M0-200S Fabricants: Grayhill, Inc. La description: ROTARY ENCODER OPTICAL 32PPR En stock: 2199 pcs</p> <p>RFQ</p> |
|  <p>62S11-M5-030C Fabricants: Grayhill, Inc. La description: ROTARY ENCODER OPTICAL 32PPR En stock: 2076 pcs</p> <p>RFQ</p> |  <p>62S11-M5-020CH Fabricants: Grayhill, Inc. La description: ROTARY ENCODER OPTICAL 32PPR En stock: 1977 pcs</p> <p>RFQ</p> |
|  <p>62S11-M5-030CH Fabricants: Grayhill, Inc. La description: ROTARY ENCODER OPTICAL 32PPR En stock: 1862 pcs</p> <p>RFQ</p> |  <p>62S11-M0-060CH Fabricants: Grayhill, Inc. La description: ROTARY ENCODER OPTICAL 32PPR En stock: 1968 pcs</p> <p>RFQ</p> |
|  <p>62S11-M5-020SH Fabricants: Grayhill, Inc. La description: ROTARY ENCODER OPT 32PPR 2" CBL En stock: 1912 pcs</p> <p>RFQ</p> |  <p>62S11-M0-PH Fabricants: Grayhill, Inc. La description: ROTARY ENCODER OPTICAL 32PPR En stock: 2503 pcs</p> <p>RFQ</p> |
|  <p>62S11-M0-P Fabricants: Grayhill, Inc. La description: ROTARY ENCODER OPTICAL 32PPR En stock: 1933 pcs</p> <p>RFQ</p> |  <p>62S11-M5-020C Fabricants: Grayhill, Inc. La description: ROTARY ENCODER OPT 32PPR 2" CBL En stock: 2181 pcs</p> <p>RFQ</p> |
|  <p>62S11-M0-060C Fabricants: Grayhill, Inc. La description: ROTARY ENCODER OPT 32PPR 6" CBL En stock: 2289 pcs</p> <p>RFQ</p> |  <p>62S11-M5-020S Fabricants: Grayhill, Inc. La description: ROTARY ENCODER OPTICAL 32PPR En stock: 2069 pcs</p> <p>RFQ</p> |