





Grayhill, Inc.

62S11-L9-020CH

Numéro d'article:	62S11-L9-020CH
Fabricant / marque:	Grayhill, Inc.
Description du produit:	ROTARY ENCODER OPTICAL 32PPR
Feuilles de données:	 62S11-L9-020CH.pdf
Statut RoHS	 Sans plomb / Conforme RoHS
Etat du stock	2264 pcs stock
Bateau de	Hong Kong
Manière d'expédition	DHL/Fedex/TNT/UPS/EMS

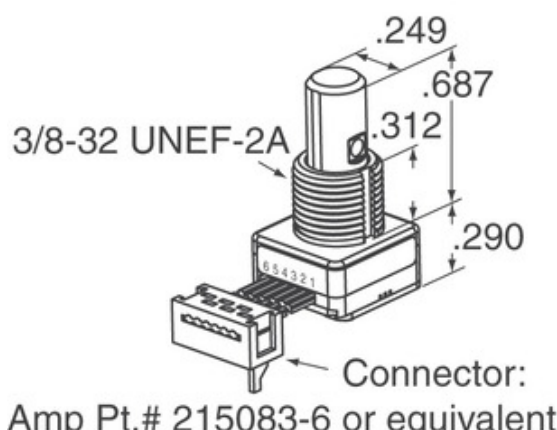
[DEMANDE DE DEVIS](#)

L'image peut être une représentation. Voir les spécifications pour les détails du produit.



Spécifications de 62S11-L9-020CH

NUMÉRO D'ARTICLE	62S11-L9-020CH
FABRICANT	Grayhill, Inc.
LA DESCRIPTION	ROTARY ENCODER OPTICAL 32PPR
ÉTAT SANS PLOMB / ÉTAT ROHS	Sans plomb / Conforme RoHS
QUANTITÉ DISPONIBLE	2264 pcs
FICHE TECHNIQUE	 62S11-L9-020CH.pdf
TENSION - ALIMENTATION	5V
STYLE DE RACCORDEMENT	Cable with Connector
SÉRIES	62S
VIE ROTATIONAL (CYCLES MIN)	1M
IMPULSIONS PAR TOUR	32
LE TYPE DE SORTIE	Quadrature (Incremental)
AUTRES NOMS	62S11L9020CH
ORIENTATION	Vertical
TYPE DE MONTAGE	Panel Mount
NIVEAU DE SENSIBILITÉ À L'HUMIDITÉ (MSL)	1 (Unlimited)
STATUT SANS PLOMB / STATUT ROHS	Lead free / RoHS Compliant
TYPE DE CODEUR	Optical
DETENT	Yes
COMMUTATEUR INTÉGRÉ	Yes
TYPE D'ACTIONNEUR	1/4" Dia Flatted End

Tags associés

Grayhill, Inc. 62S11-L9-020CH	Distributeur 62S11-L9-020CH	62S11-L9-020CH Fournisseur
Prix 62S11-L9-020CH	62S11-L9-020CH Photos	Image 62S11-L9-020CH
62S11-L9-020CH PDF Fiche technique	62S11-L9-020CH Télécharger la fiche technique	62S11-L9-020CH Fiche technique
Action 62S11-L9-020CH	Acheter 62S11-L9-020CH	Acheter Grayhill, Inc. 62S11-L9-020CH
Grayhill, Inc. 62S11-L9-020CH	Grayhill, Inc. Fournisseur	Distributeur Grayhill, Inc.
Grayhill, Inc. 62S11-L9-020CH	Grayhill Inc. 62S11-L9-020CH	

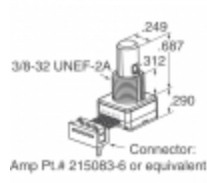
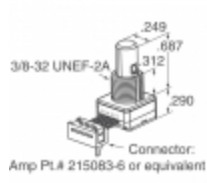
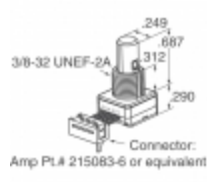
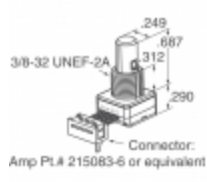
Produits connexes

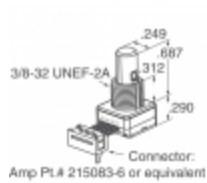
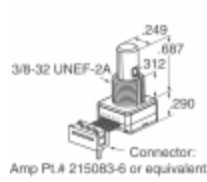
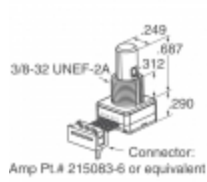
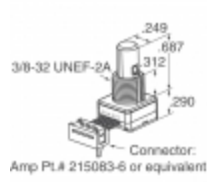
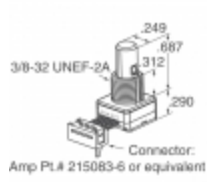
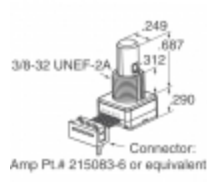
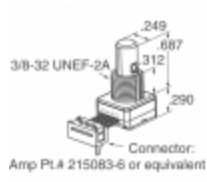
 <p>62S11-L9-020S Fabricants: Grayhill, Inc. La description: ROTARY ENCODER OPTICAL 32PPR En stock: 2134 pcs</p> <p>RFQ</p>	 <p>62S11-L5-P Fabricants: Grayhill, Inc. La description: ROTARY ENCODER OPTICAL 32PPR En stock: 2265 pcs</p> <p>RFQ</p>
 <p>62S11-L5-040C Fabricants: Grayhill, Inc. La description: ROTARY ENCODER OPTICAL 32PPR En stock: 1990 pcs</p> <p>RFQ</p>	 <p>62S11-L9-040C Fabricants: Grayhill, Inc. La description: ROTARY ENCODER OPTICAL 32PPR En stock: 1938 pcs</p> <p>RFQ</p>
 <p>62S11-L5-PH Fabricants: Grayhill, Inc. La description: ROTARY ENCODER OPTICAL 32PPR En stock: 2218 pcs</p> <p>RFQ</p>	 <p>62S11-L9-PH Fabricants: Grayhill, Inc. La description: ROTARY ENCODER OPTICAL 32PPR En stock: 1972 pcs</p> <p>RFQ</p>
 <p>62S11-M0-020C Fabricants: Grayhill, Inc. La description: ROTARY ENCODER OPT 32PPR 2" CBL En stock: 1812 pcs</p> <p>RFQ</p>	 <p>62S11-L9-020SH Fabricants: Grayhill, Inc. La description: ROTARY ENCODER OPTICAL 32PPR En stock: 1952 pcs</p> <p>RFQ</p>
 <p>62S11-L5-060C Fabricants: Grayhill, Inc. La description: ROTARY ENCODER OPTICAL 32PPR En stock: 2163 pcs</p> <p>RFQ</p>	 <p>62S11-L9-020C Fabricants: Grayhill, Inc. La description: ROTARY ENCODER OPTICAL 32PPR En stock: 1773 pcs</p> <p>RFQ</p>
 <p>62S11-M0-020SH Fabricants: Grayhill, Inc. La description: ROTARY ENCODER OPT 32PPR 2" CBL En stock: 2051 pcs</p> <p>RFQ</p>	 <p>62S11-L5-050CH Fabricants: Grayhill, Inc. La description: ROTARY ENCODER OPTICAL 32PPR En stock: 2186 pcs</p> <p>RFQ</p>

Copyright © 2020 Distributeur fiable de composants électroniques

Email: Info@infinity-electronic.com

Adresse: 17F, bâtiment commercial Gaylord, 114-118 Lockhart Road, Wan Chai, Hong Kong

