





Grayhill, Inc.

62S11-L4-030S

Número d'article:	62S11-L4-030S
Fabricant / marque:	Grayhill, Inc.
Description du produit:	ROTARY ENCODER OPTICAL 32PPR
Feuilles de données:	 62S11-L4-030S.pdf
Statut RoHS	 Sans plomb / Conforme RoHS
Etat du stock	1829 pcs stock
Bateau de	Hong Kong
Manière d'expédition	DHL/Fedex/TNT/UPS/EMS

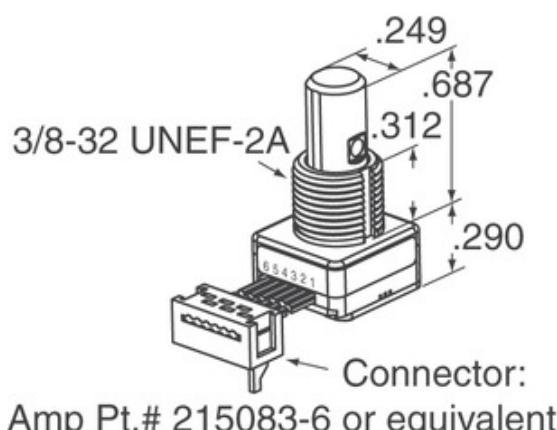
[DEMANDE DE DEVIS](#)

L'image peut être une représentation. Voir les spécifications pour les détails du produit.





Spécifications de 62S11-L4-030S

NUMÉRO D'ARTICLE	62S11-L4-030S
FABRICANT	Grayhill, Inc.
LA DESCRIPTION	ROTARY ENCODER OPTICAL 32PPR
ÉTAT SANS PLOMB / ÉTAT ROHS	Sans plomb / Conforme RoHS
QUANTITÉ DISPONIBLE	1829 pcs
FICHE TECHNIQUE	 62S11-L4-030S.pdf
TENSION - ALIMENTATION	5V
STYLE DE RACCORDEMENT	Cable Leads
SÉRIES	62S
VIE ROTATIONAL (CYCLES MIN)	1M
IMPULSIONS PAR TOUR	32
LE TYPE DE SORTIE	Quadrature (Incremental)
AUTRES NOMS	62S11L4030S
ORIENTATION	Vertical
TYPE DE MONTAGE	Panel Mount
NIVEAU DE SENSIBILITÉ À L'HUMIDITÉ (MSL)	1 (Unlimited)
STATUT SANS PLOMB / STATUT ROHS	Lead free / RoHS Compliant
TYPE DE CODEUR	Optical
DETENT	Yes
COMMUTATEUR INTÉGRÉ	Yes
TYPE D'ACTIONNEUR	1/4" Dia Flatted End

Tags associés

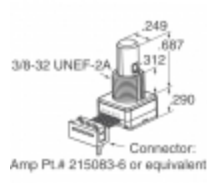
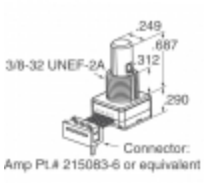
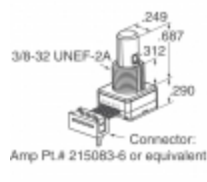
Grayhill, Inc. 62S11-L4-030S	Distributeur 62S11-L4-030S	62S11-L4-030S Fournisseur
Prix 62S11-L4-030S	62S11-L4-030S Photos	Image 62S11-L4-030S
62S11-L4-030S PDF Fiche technique	62S11-L4-030S Télécharger la fiche technique	62S11-L4-030S Fiche technique
Action 62S11-L4-030S	Acheter 62S11-L4-030S	Acheter Grayhill, Inc. 62S11-L4-030S
Grayhill, Inc. 62S11-L4-030S	Grayhill, Inc. Fournisseur	Distributeur Grayhill, Inc.
Grayhill, Inc. 62S11-L4-030S	Grayhill Inc. 62S11-L4-030S	

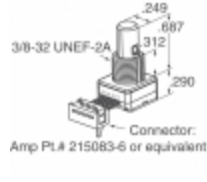
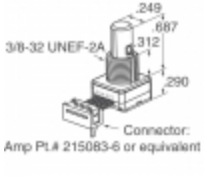
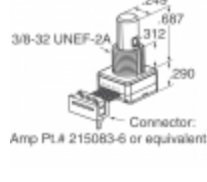
Produits connexes

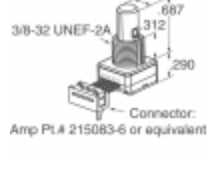
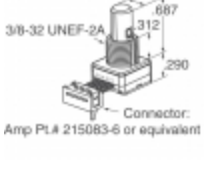
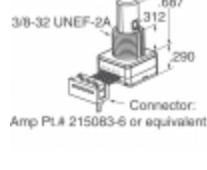
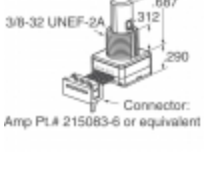
 <p>62S11-L0-PHV Fabricants: Grayhill, Inc. La description: ROTARY ENCODER OPTICAL 32PPR En stock: 1991 pcs</p> <p>RFQ</p>	 <p>62S11-L4-040CH Fabricants: Grayhill, Inc. La description: ROTARY ENCODER OPTICAL 32PPR En stock: 1716 pcs</p> <p>RFQ</p>
 <p>62S11-L4-040C Fabricants: Grayhill, Inc. La description: ROTARY ENCODER OPTICAL 32PPR En stock: 2290 pcs</p> <p>RFQ</p>	 <p>62S11-L4-050CH Fabricants: Grayhill, Inc. La description: ROTARY ENCODER OPT 32PPR 4" CBL En stock: 2019 pcs</p> <p>RFQ</p>
 <p>62S11-L4-080C Fabricants: Grayhill, Inc. La description: ROTARY ENCODER OPTICAL 32PPR En stock: 1843 pcs</p> <p>RFQ</p>	 <p>62S11-L4-020C Fabricants: Grayhill, Inc. La description: ROTARY ENCODER OPTICAL 32PPR En stock: 2162 pcs</p> <p>RFQ</p>
 <p>62S11-L4-020S Fabricants: Grayhill, Inc. La description: ROTARY ENCODER OPT 32PPR 2" CBL En stock: 1879 pcs</p> <p>RFQ</p>	 <p>62S11-L4-050C Fabricants: Grayhill, Inc. La description: ROTARY ENCODER OPT 32PPR 4" CBL En stock: 2211 pcs</p> <p>RFQ</p>
 <p>62S11-L0-P Fabricants: Grayhill, Inc. La description: ROTARY ENCODER OPTICAL 32PPR En stock: 2100 pcs</p> <p>RFQ</p>	 <p>62S11-L4-080CH Fabricants: Grayhill, Inc. La description: ROTARY ENCODER OPTICAL 32PPR En stock: 1886 pcs</p> <p>RFQ</p>
 <p>62S11-L4-025SH Fabricants: Grayhill, Inc. La description: ROTARY ENCODER OPTICAL 32PPR En stock: 2264 pcs</p> <p>RFQ</p>	 <p>62S11-L0-PH Fabricants: Grayhill, Inc. La description: ROTARY ENCODER OPTICAL 32PPR En stock: 2460 pcs</p> <p>RFQ</p>

Copyright © 2020 Distributeur fiable de composants électroniques

Email: Info@infinity-electronic.com

Adresse: 17F, bâtiment commercial Gaylord, 114-118 Lockhart Road, Wan Chai, Hong Kong

