



Grayhill, Inc.

62S11-M9-025S

Numéro d'article:

62S11-M9-025S

Fabricant / marque:

Grayhill, Inc.

Description du produit

ROTARY ENCODER OPTICAL 32PPR

Feuilles de données:

 62S11-M9-025S.pdf

Statut RoHS

 Sans plomb / Conforme RoHS

Etat du stock

2070 pcs stock

Bateau de

Hong Kong

Manière d'expédition

DHL/Fedex/TNT/UPS/EMS

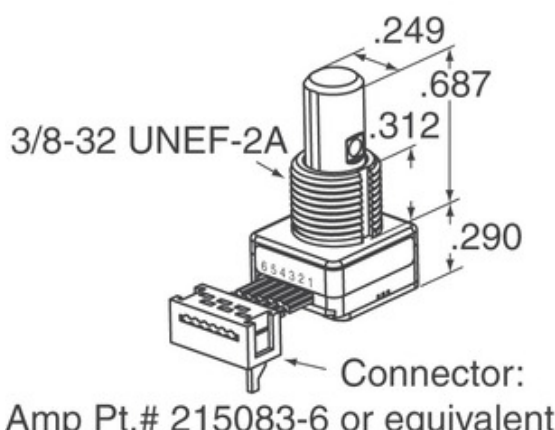

L'image peut être une représentation. Voir les spécifications pour les détails du produit.

[DEMANDE DE DEVIS](#)





Spécifications de 62S11-M9-025S

NUMÉRO D'ARTICLE	62S11-M9-025S
FABRICANT	Grayhill, Inc.
LA DESCRIPTION	ROTARY ENCODER OPTICAL 32PPR
ÉTAT SANS PLOMB / ÉTAT ROHS	Sans plomb / Conforme RoHS
QUANTITÉ DISPONIBLE	2070 pcs
FICHE TECHNIQUE	 62S11-M9-025S.pdf
TENSION - ALIMENTATION	5V
STYLE DE RACCORDEMENT	Cable Leads
SÉRIES	62S
VIE ROTATIONAL (CYCLES MIN)	1M
IMPULSIONS PAR TOUR	32
LE TYPE DE SORTIE	Quadrature (Incremental)
AUTRES NOMS	62S11M9025S
ORIENTATION	Vertical
TYPE DE MONTAGE	Panel Mount
NIVEAU DE SENSIBILITÉ À L'HUMIDITÉ (MSL)	1 (Unlimited)
STATUT SANS PLOMB / STATUT ROHS	Lead free / RoHS Compliant
TYPE DE CODEUR	Optical
DETENT	Yes
COMMUTATEUR INTÉGRÉ	Yes
TYPE D'ACTIONNEUR	1/4" Dia Flatted End

Tags associés

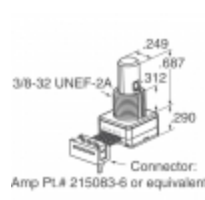
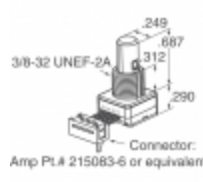
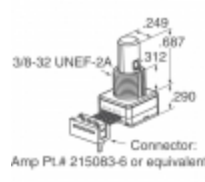
Grayhill, Inc. 62S11-M9-025S	Distributeur 62S11-M9-025S	62S11-M9-025S Fournisseur
Prix 62S11-M9-025S	62S11-M9-025S Photos	Image 62S11-M9-025S
62S11-M9-025S PDF Fiche technique	62S11-M9-025S Télécharger la fiche technique	62S11-M9-025S Fiche technique
Action 62S11-M9-025S	Acheter 62S11-M9-025S	Acheter Grayhill, Inc. 62S11-M9-025S
Grayhill, Inc. 62S11-M9-025S	Grayhill, Inc. Fournisseur	Distributeur Grayhill, Inc.
Grayhill, Inc. 62S11-M9-025S	Grayhill Inc. 62S11-M9-025S	

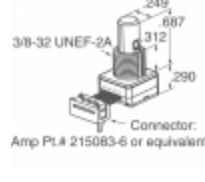
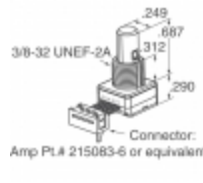
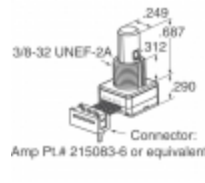
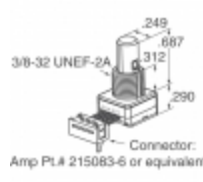
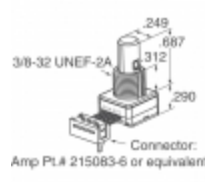
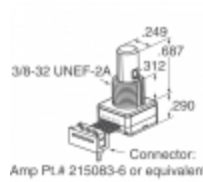
Produits connexes

 <p>62S11-M5-P Fabricants: Grayhill, Inc. La description: ROTARY ENCODER OPTICAL 32PPR En stock: 2458 pcs</p> <p>RFQ</p>	 <p>62S11-M9-095CH Fabricants: Grayhill, Inc. La description: ROTARY ENCODER OPTICAL 32PPR En stock: 1978 pcs</p> <p>RFQ</p>
 <p>62S11-M9-020C Fabricants: Grayhill, Inc. La description: ROTARY ENCODER OPTICAL 32PPR En stock: 2241 pcs</p> <p>RFQ</p>	 <p>62S11-M9-020S Fabricants: Grayhill, Inc. La description: ROTARY ENCODER OPTICAL 32PPR En stock: 2269 pcs</p> <p>RFQ</p>
 <p>62S11-M9-020CH Fabricants: Grayhill, Inc. La description: ROTARY ENCODER OPTICAL 32PPR En stock: 2097 pcs</p> <p>RFQ</p>	 <p>62S11-M9-040C Fabricants: Grayhill, Inc. La description: ROTARY ENCODER OPTICAL 32PPR En stock: 1933 pcs</p> <p>RFQ</p>
 <p>62S11-M9-060C Fabricants: Grayhill, Inc. La description: ROTARY ENCODER OPTICAL 32PPR En stock: 2060 pcs</p> <p>RFQ</p>	 <p>62S11-M9-040SH Fabricants: Grayhill, Inc. La description: ROTARY ENCODER OPT 32PPR 4" CBL En stock: 1879 pcs</p> <p>RFQ</p>
 <p>62S11-M9-050C Fabricants: Grayhill, Inc. La description: ROTARY ENCODER OPTICAL 32PPR En stock: 2082 pcs</p> <p>RFQ</p>	 <p>62S11-M9-030S Fabricants: Grayhill, Inc. La description: ROTARY ENCODER OPTICAL 32PPR En stock: 1918 pcs</p> <p>RFQ</p>
 <p>62S11-M5-135S Fabricants: Grayhill, Inc. La description: ROTARY ENCODER OPTICAL 32PPR En stock: 2167 pcs</p> <p>RFQ</p>	 <p>62S11-M5-PH Fabricants: Grayhill, Inc. La description: ROTARY ENCODER OPTICAL 32PPR En stock: 2451 pcs</p> <p>RFQ</p>